

## Chapter 2

### Two Kinds of Reasoning

This chapter offers more detail on argument and logic. If you emphasize formal logic in your course, you might want to go over this chapter and then move directly to Chapters 9-11. If you skip formal logic, you could conceivably omit this chapter and move on to Chapters 4 through 8.

An *argument* consists of two parts. One part, the *premise*, is intended to provide a reason for accepting the second part, the *conclusion*. (Sometimes in everyday talk, “argument” is used synonymously with “premise.”)

- The conclusion of one argument can be the premise of another argument.
- An argument may have unstated premises; and it may have an unstated conclusion.

The premise or premises of a good *deductive* argument, if true, *demonstrate (prove)* the conclusion.

It sounds odd to speak of a deductive argument as providing “evidence” for a conclusion.

A deductive argument is *valid* if it is impossible for the conclusion to be false given the premise or premises, “impossible” not in the sense of beyond a reasonable doubt but in the sense of beyond a conceivable doubt. It is *sound* if it is valid and all premises are true.

The premise or premises of a good *inductive* argument, if true, *support* the conclusion. One argument for a conclusion is stronger than another if it raises the probability of the conclusion by a greater amount. It is weaker than another, if it fails to raise the probability of the conclusion by as much.

You can transform any inductive argument into a valid deductive argument by supplying the right universal premise. If the premise must be unqualified, sweeping, and implausible, that indicates the argument probably was meant to be inductive.

Trying to determine which considerations, both for and against doing or thinking something, carry the most weight, is known as *balance of considerations* reasoning.

An *inference to the best explanation* (IBE) is an argument whose conclusion explains the cause of something.

These are not arguments:

- Pictures, movies, toadstools, gas, or any other non-propositional entity
- If/then sentences
- Lists of facts
- “A because B” statements, where “B” states the cause or explanation of something.

Aristotle distinguished three modes by which a speaker may persuade an audience: *ethos* (the speaker's personal attributes), *pathos* (emotional appeals), and *logos* (rational argument). *Logos* often does not persuade people, which is why we have critical thinking courses.

One cannot define an argument as an attempt to persuade. Persuasion is evaluated by its psychological efficacy. Argument evaluations contain two aspects: (1) the logic part: do the premises demonstrate (prove) or support the conclusion; and (2) the truth part: are the premises true? In other words, they are evaluated by the criteria of deductive validity and inductive strength. Since people can be persuaded by weak and unsound arguments, and remain unfazed by arguments that are strong or sound, arguments cannot be defined as attempts to persuade.

Various considerations, mentioned on pages 48 and 49, can make it hard to decipher arguments. An argument's structure, however, can sometimes be disclosed by diagramming it. One set of diagramming techniques is explained on pages 49-51.

## Answers to Text Exercises

### Exercise 2-1

- ▲ 1. a. Premise; b. premise; c. conclusion
- ▲ 2. a. Premise; b. premise; c. conclusion
- ▲ 3. a. Conclusion; b. premise
- ▲ 4. a. Premise; b. premise; c. conclusion
- ▲ 5. a. Premise; b. conclusion; c. premise; d. premise

### Exercise 2-2

- ▲ 1. Premise: All Communists are Marxists.  
Conclusion: All Marxists are Communists.
- 2. Premise: The Lakers almost didn't beat the Kings.  
Conclusion: They'll never get past Dallas.
- 3. Premise: If the butler had done it, he could not have locked the screen door.  
Premise: The door was locked.  
Conclusion: The butler is in the clear.
- ▲ 4. Premise: That cat is used to dogs.  
Conclusion: Probably she won't be upset if you bring home a new dog for a pet.
- 5. Premise: His mother's daughter has only one brother.  
Conclusion: He isn't older than his mother's daughter's brother.
- 6. Premises: The state police have a weight limit, and Mr. Hoover is over it.  
Conclusion: Mr. Hoover will never make it into the state police.

- ▲ 7. Premise: Presbyterians are not fundamentalists.  
Premise: All born-again Christians are fundamentalists.  
Conclusion: No born-again Christians are Presbyterians.
- 8. Premise: Thork wastes his time watching daytime TV.  
Conclusion: Thork doesn't have a thing to do.
- 9. Premise: There are more injuries in professional football today than there were twenty years ago.  
Premise: If there are more injuries, then today's players suffer higher risks.  
Premise: If today's players suffer higher risks, then they should be paid more.  
Conclusion: Today's players should be paid more.
- ▲ 10. Premise: The clunk comes only when I pedal.  
Conclusion: The problem is in the chain, the crank, or the pedals.

### Exercise 2-3

- ▲ 1. Conclusion: There is a difference in the octane ratings between the two grades of gasoline.
- 2. Premise: Kera, Sherry, and Bobby were all carded at JJ's.  
Premise: They all look as though they're about thirty.  
Conclusion: I'll be carded JJ's.
- 3. Premise: Seventy percent of the freshmen at Cal Poly San Luis Obispo come from wealthy families.  
Conclusion: About the same percentage of all Cal Poly San Luis Obispo students come from wealthy families.
- ▲ 4. Conclusion: Scrub jays can be expected to be aggressive when they're breeding.
- 5. Premise: Marietta told me her parents benefited from the cut in the capital gains tax.  
Conclusion: Marietta comes from a wealthy family.
- 6. Premise: According to *Nature*, today's thoroughbred racehorses do not run any faster than their grandparents did.  
Premise: Human Olympic runners are at least 20 percent faster than their counterparts of fifty years ago.  
Conclusion: Racehorses have reached their physical limits but humans have not.
- ▲ 7. Conclusion: Dogs are smarter than cats.
- 8. Premise: If this bucket has a hole in it, then it will leak.  
Premise: It doesn't leak.  
Conclusion: It doesn't have a hole in it.

9. Premise: She's from Alamo Polytech.  
Premise: The last person we hired from there was incompetent.  
Conclusion: We shouldn't take a chance on this new candidate.

▲10. Unstated conclusion: She is not still interested in me.

#### Exercise 2-4

- ▲1. Deductive  
2. Inductive  
3. Deductive  
▲4. Inductive  
5. Deductive  
6. Inductive  
▲7. Inductive  
8. Deductive  
9. Inductive  
▲10. Deductive

#### Exercise 2-5

- ▲1. Inductive (The premises if true do not make it impossible for the conclusion to be false.)  
2. Deductive  
3. Inductive  
▲4. Inductive  
5. Inductive  
6. Inductive  
▲7. Deductive (with the unstated premise: If I didn't get enough sleep last night I should get to bed earlier tonight.)  
8. Inductive  
9. Inductive  
▲10. Inductive

#### Exercise 2-6

- ▲1.b  
2. a  
3. c  
▲4.b

- 5. c
- 6. a
- ▲ 7. b
- 8. a
- 9. b
- ▲ 10. b

### **Exercise 2-7**

- ▲ 1. a
- 2. c
- 3. b
- ▲ 4. a
- 5. b
- 6. c
- ▲ 7. b
- 8. b
- 9. a
- ▲ 10. c

### **Exercise 2-8**

- ▲ 1. Inductive
- 2. False
- 3. True
- ▲ 4. True
- 5. True
- 6. False
- ▲ 7. Deductive
- 8. False
- 9. False
- ▲ 10. Inductive
- 11. False
- 12. False
- ▲ 13. True
- 14. True
- 15. False
- 16. False
- ▲ 17. False

18. True

**Exercise 2-9**

- ▲ 1. Deductive demonstration
- ▲ 2. Inductive support
  - 3. Deductive demonstration
- ▲ 4. Inductive support
  - 5. Deductive demonstration
  - 6. Inductive support
- ▲ 7. Two arguments here: In the first argument, if the speaker is assuming that the universe's not having arisen by chance increases the probability that God exists, then his or her argument is inductive. Likewise, in the second argument, if the speaker is assuming that an increase in the number of believing physicists increases the probably that God exists, then his or her argument is inductive.
- ▲ 8. Inductive support

**Exercise 2-10**

**Item 1**

1. North Korea is a great threat to its neighbors.
2. It has a million-person army ready to be unleashed at a moment's notice.
3. It also has nuclear weapons.



**Item 2**

1. **Shaun is going to the party with Mary.**
2. **She won't be going alone.**



**Item 3**

1. Michael should just go ahead and get a new car.
2. The one he's driving is junk.
3. He has a new job and can afford a car.



**Item 4**

1. If Karper goes to Las Vegas, he'll wind up in a casino.
2. If he winds up in a casino, it's a sure thing he'll spend half the night at a craps table.
3. If Karper goes to Las Vegas, he'll spend half the night at a craps table.

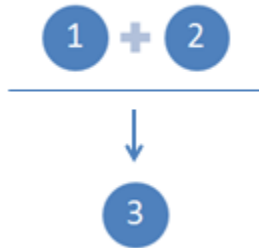

**Item 5**

1. It's going to be rainy tomorrow.
2. Serj doesn't like to play in the rain.
3. It's going to be cold as well.
4. Serj really doesn't like to play when it's cold.
5. Serj will be someplace other than the golf course tomorrow.

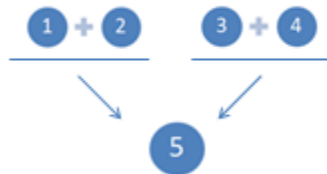

**Item 6**

1. You're overwatering your lawn.
2. There are mushrooms growing around the base of that tree – a sure sign of overwatering.
3. Look at all the worms on the ground.
4. They come up when the earth is saturated.

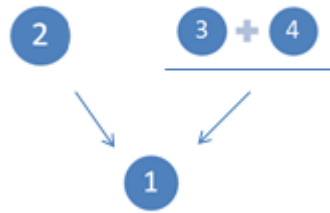

**Item 7**

1. **You will drive me to the airport.**
2. **I'll pay you twice what it takes for gas.**
3. **You said you were my friend.**



**Item 8**

1. **If you drive too fast, you're more likely to get a ticket.**
2. **The more likely you are to get a ticket, the more like you are to have your insurance premiums raised.**
3. **If you drive too fast, you are more likely to have your insurance premiums raised.**

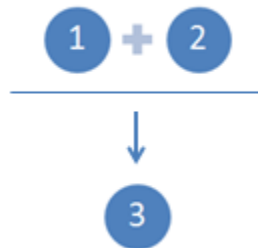

**Item 9**

1. **If you drive too fast, you're more likely to get a ticket.**
2. **You're also more likely to get into an accident.**
3. **You shouldn't drive too fast.**





**Item 10**

1. **You should consider installing a solarium.**
2. **You can still get a tax credit**
3. **You can reduce your heating bill.**
4. **If you build it right, you can actually cool your house with it in the summer.**

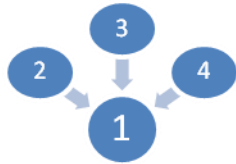

**Item 11**

1. **By trying to eliminate Charles Darwin from the curriculum, creationists are doing themselves a great disservice.**
2. **When read carefully, Darwin's discoveries only support the thesis that species change, not they evolve into new species.**
3. **This is a thesis that most creationists can live with.**
4. **When read carefully, Darwin actually supports the creationist point of view.**

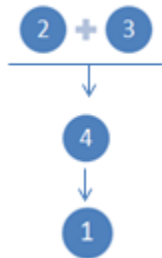

**Item 12**

1. **The Supreme Court's ruling is sound.**
2. **Nothing stops someone from saying a silent prayer at school or anyone else.**
3. **Even though a moment of silence will encourage prayer, it will not favor any particular religion over any other.**
4. **The ruling makes sense.**

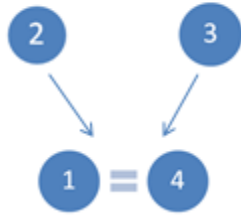

**Item 13**

1. **We must paint the house now.**
2. **If we don't then we'll have to paint it next summer.**
3. **If we have to paint it next summer, we'll have to cancel our trip.**
4. **It's too late to cancel the trip.**

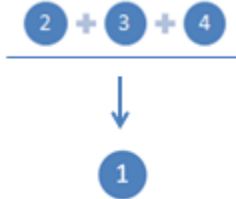

**Exercise 2-11**

- ▲ 1. "Because" is followed by a cause
- 2. "Because" is followed by a cause
- 3. "Because" is followed by a premise
- ▲ 4. "Because" is followed by a cause
- 5. "Because" is followed by a premise
- 6. "Because" is followed by a premise
- ▲ 7. "Because" is followed by a cause
- 8. "Because" is followed by a premise
- ▲ 9. "Because" is followed by a premise
- 10. "Because" is followed by a cause

**Exercise 2-12**

- ▲ 1. Could not possibly be false
- 2. Could possibly be false
- 3. Could possibly be false
- ▲ 4. Could not possibly be false

- 5. Could possibly be false
- 6. Could not possibly be false
- ▲7. Could not possibly be false
- 8. Could possibly be false
- 9. Could possibly be false
- ▲10. Could not possibly be false

**Exercise 2-13**

- ▲1. Anyone who keeps his or her word is a person of good character.
  - 2. You can't get an A in a course without having gotten an A on the final.
  - 3. We have a right to invade any country that poses a threat to us.
- ▲4. One cannot murder someone without being in the same room.
  - 5. Anyone who votes against gun control is not a liberal.
  - 6. People with gentle souls go to heaven.
- ▲7. Anyone who commits murder should be executed.
  - 8. If only 8 people show up the party isn't a success.
  - 9. If someone proved Goldbach's conjecture, he or she is the greatest mathematician ever.
- ▲10. All squeaking fans need oil.

**Exercise 2-14**

- ▲1. Puddles everywhere usually indicate a recent rain.
  - 2. Most likely the battery is weak if the lights are dim.
  - 3. Probably Simpson's blood wouldn't match that on the glove found at the victim's condo if Simpson hadn't killed her.
- ▲4. The next day after a week of cold weather usually is cold.
  - 5. People who aren't very good with animals generally don't make good parents.
  - 6. When a dog scratches a lot it is almost always due to fleas or dry skin.
- ▲7. Having leftovers is an indication that a party wasn't successful.
  - 8. Rifle owners usually belong to the NRA.
  - 9. Eating a dessert with caffeine can interfere with your sleep.
- ▲10. My cold probably would not have disappeared like magic if I had not taken Zicam.

**Exercise 2-15**

- 1.

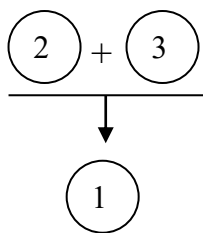

2.

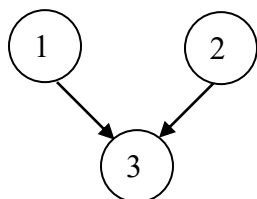

3.

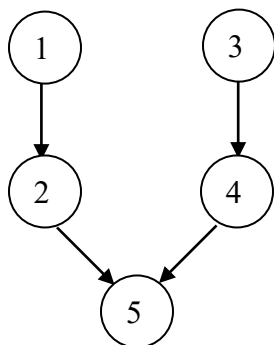

4.

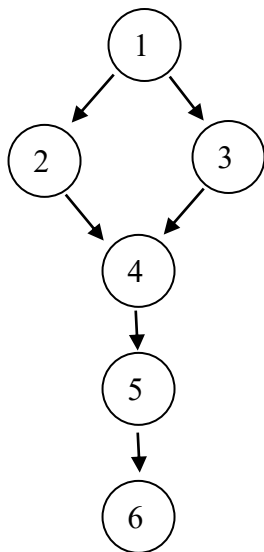

5.

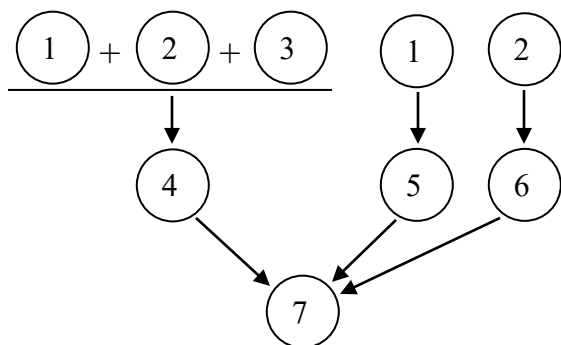

**Exercise 2-16**

- ▲ 1.a
- 2.b
- 3.a
- ▲ 4.a
- 5.a

### Exercise 2-17

- ▲ 1. 1. Your distributor is the problem.  
2. There's no current at the spark plugs.  
3. If there's no current at the plugs, then either your alternator is shot or your distributor is defective.  
4. [Unstated:] Either your alternator is shot, or your distributor is defective.  
5. If the problem were in the alternator, then your dash warning light would be on.  
6. The light isn't on.

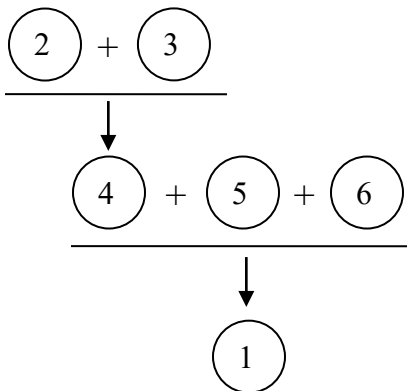

2. 1. The slide in the dollar must be stopped.  
2. It contributes to inflation.  
3. It increases the cost of imports.  
4. It helps exports.  
5. On balance it is bad for the economy.

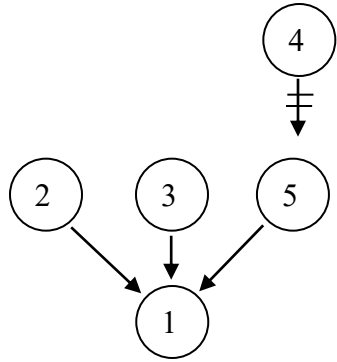

3. 1. Professional boxing should be outlawed.
2. Boxing almost always leads to brain damage.
3. Anything that leads to brain damage should be outlawed.
4. Boxing supports organized crime.
5. [Unstated:] Anything that supports organized crime should be outlawed.

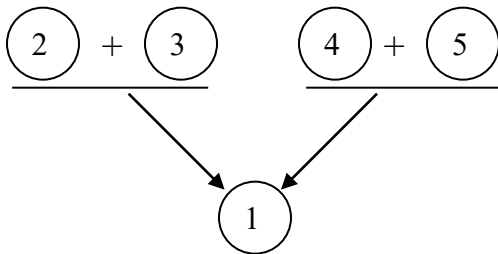

- ▲4. 1. They really ought to build a new airport.
2. It [a new airport] would attract more business to the area.
3. The old airport is overcrowded and dangerous.

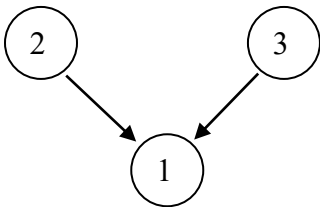

Note: Claim 3 could be divided into two separate claims, one about overcrowding and one about danger. This would be important if the overcrowding were clearly offered as a reason for the danger.

5. 1.(And 6) You shouldn't vote for Cuomo.
2. He's too radical.
3. He's too inexperienced.
4. These two things make him dangerous.
5. I like his stand on trade.

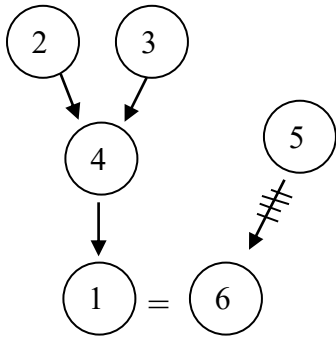

**Exercise 2-18**

- ▲ 1. 1. Cottage cheese will help you to be slender.
- 2. Cottage cheese will help you to be youthful.
- 3. Cottage cheese will help you to be more beautiful.
- 4. Enjoy cottage cheese often.

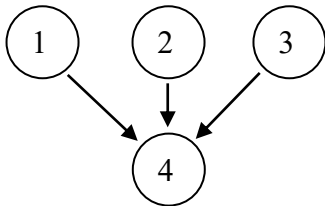

- 2. 1. You should listen to loud music only when we are not at home.
- 2. It [loud music] bothers us.
- 3. We're your parents.
- 4. [Unstated:] You shouldn't do things that bother your parents.

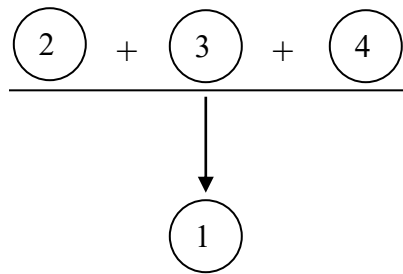

- 3. 1. The 1948 version of *The Three Musketeers* is the best version.
- 2. Lana Turner is luscious (in the 1948 version).
- 3. Vincent Price is dastardly.
- 4. Angela Lansbury is regal.
- 5. Nobody has or will portray D'Artagnan with the grace, athleticism, or skill of Gene



Kelly.

6. You should download the 1948 version of the movie.

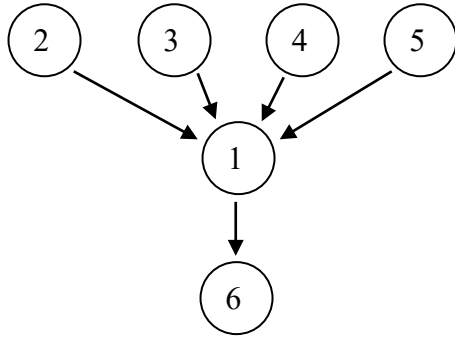

▲4. 1. The idea of a free press in America is a joke.

2. Advertisers control the media more effectively than if they owned it outright.

3. Advertisers, through fear of boycott, can dictate programming.

4. Politicians and editors shiver at the thought of a boycott.

5. The situation is intolerable.

6. I suggest we all listen to NPR and public television.

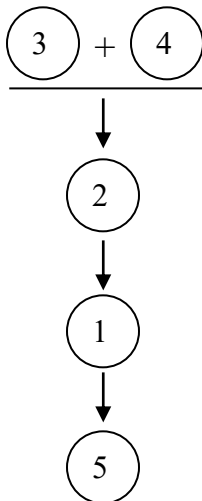

Note: The writer may see claim 1 as the final conclusion and claim 5 as his comment upon it. Claim 6 is probably a comment on the results of the argument, although it, too, could be listed as a further conclusion.

5. 1. Too many older Americans . . . are paying far too much . . . for housing.

2. Proposition 168 will help clear the way for affordable housing for these groups.

3. Proposition 168 reforms the . . . requirements for an election before . . . approved.

4. Requiring elections . . . wastes money.
5. No other state constitution puts such a roadblock. . . .
6. Please support Proposition 168. [i.e., you should support Proposition 168.]

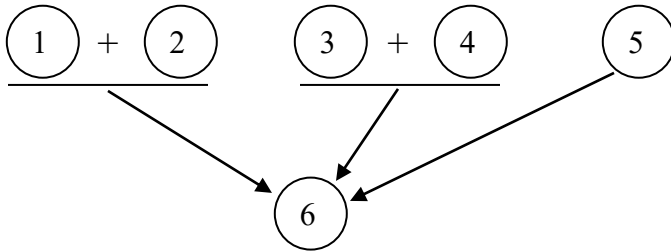

6. 1. Decades after . . . it's no easier to accept . . .
2. There is no credible evidence to contradict the Warren Commission finding . . .
3. It is time to accept the conclusion [of the Warren Commission].
4. The nation pays a heavy price for chronic doubts and mistrust.
5. Confidence in the government has declined.
6. Participation in the voting process has steadily slid downward.
7. The national appetite for wild theories encourages peddlers to persist.
8. Evil is never easy to accept.

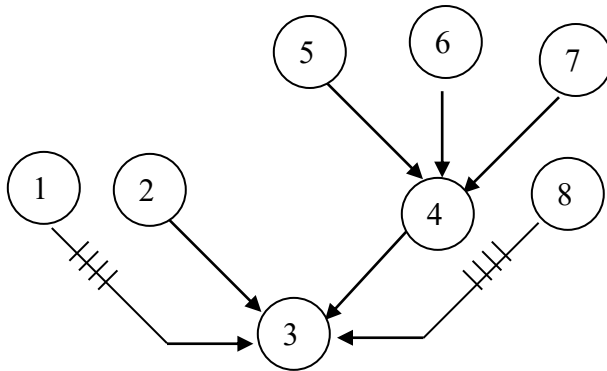

*Notice that claims 1 and 8 could easily be considered window dressing and simply ignored.*

- ▲7. 1. Most schools should offer single-sex classes.
2. Single-sex classes promote learning.
3. Girls do better in math and science courses when they are alone with other girls.
4. Gender offers distractions that interfere with learning.
5. Research also shows that in mixed classrooms most instructors will spend more time answering questions from boys.
6. Schools that offer single-sex classes always report learning gains for students of both sexes.

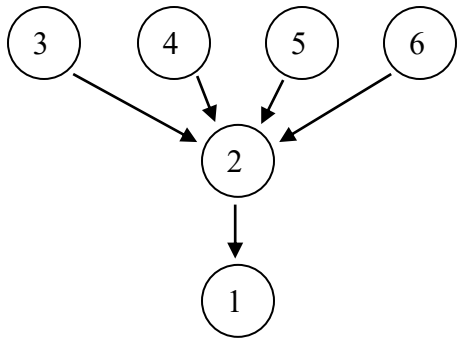

8. 1. The nation’s cities reel under staggering murder totals.
2. Kids use guns simply to get even after feuds.
3. Children are gunned down by random bullets.
4. This is not exactly the weapon of choice for deer hunting or for a homeowner seeking protection.
5. It is an ideal weapon for street gangs and drug thugs in their wars with each other and the police.
6. To legalize fully automatic machine guns is to increase the mayhem that is turning this nation—particularly its large cities—into a continual war zone.
7. The NRA must have something better to do [than wanting the Court to throw out the ban on private ownership of fully automatic weapons].

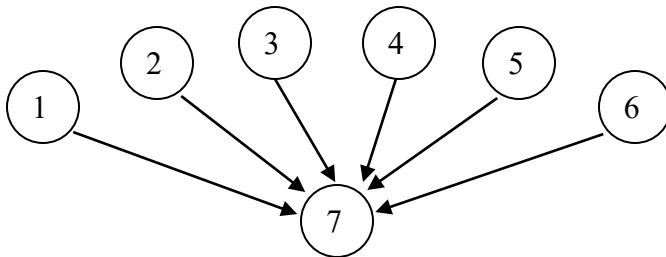

9. 1. Our right to move about freely is more important than having a checkpoint system for drunk drivers.
2. If the checkpoint system continues, there will be checkpoints for drugs, seat belts, and so on.
3. We’ll regret it later if we allow the system to continue.
4. [Unstated:] We’ll regret it if we get checkpoints for drugs, seat belts, and so

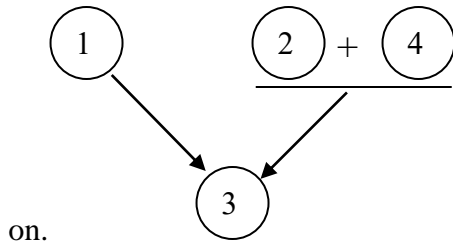

*Since no evidence is given for claim 2, this has the distinct aroma of the slippery slope fallacy.*

- ▲ 10. 1. Well-located, sound real estate is the safest investment in the world.  
 2. Real estate is not going to disappear as can dollars in savings accounts.  
 3. Real estate values are not lost because of inflation.  
 4. Property values tend to increase at a pace at least equal to the rate of inflation.  
 5. Most homes have appreciated at a rate greater than the inflation rate....

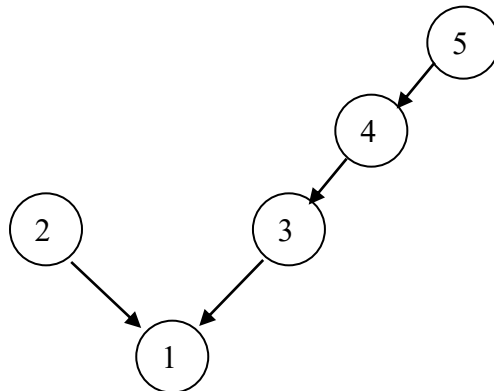

11. 1. The constitutional guarantee of a speedy trial prevents crime.  
 2. More than a third of those with serious criminal records . . . are arrested for new offenses while free on bond awaiting . . . trial.  
 3. The longer the delay, the greater the likelihood of further violations.

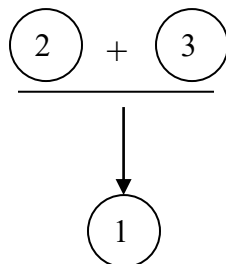

- ▲ 12. 1. About 200 million Americans are producing data on the Internet....  
 2. Each user is tracked, so private information is available in electronic form.  
 3. One Web site ... promises, for seven dollars, to scan ..., etc.  
 4. The combination of capitalism and technology poses a threat to our privacy.

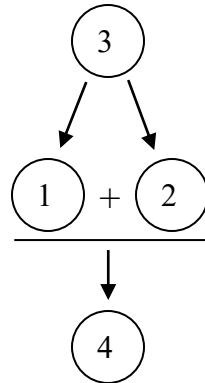

13. 1. Recycled water in automatic car washes may dump salt and dirt from one car to the next.  
 2. Brushes and drag cloths hurt the finish.  
 3. [Unstated:] ICA-sponsored tests don't really prove that automatic car washes are easier on cars than home washes.  
 4. The home washes in the tests may not have been "average."  
 5. The automatic washes in the tests were surely in perfect working order (that is, in better condition than the "average" automatic wash).  
 6. Most automatic car washes may not be properly maintained (we can't tell).  
 7. If you follow a mud-caked pickup through the wash, there may be dirt in the brushes or cloths that are dragged over your car.  
 8. You should wash your own car. (*Or: You're better off washing your own car; or: Home washing is easier on your car than automatic car washes.*)

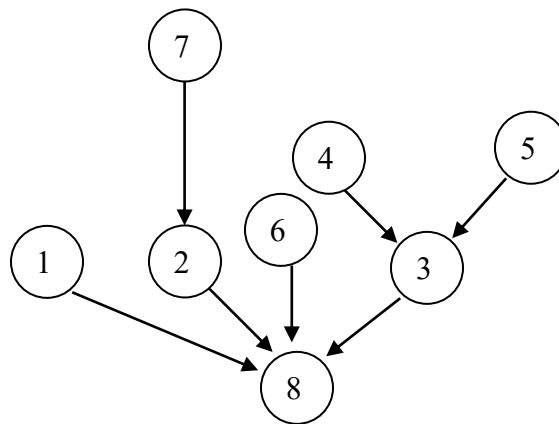

- ▲ 14. 1. Measure A is consistent with the city’s General Plan and city policies....  
 2. A “yes” vote will affirm the wisdom of well-planned, orderly growth....  
 3. Measure A substantially reduces the amount of housing previously approved for Rancho Arroyo.  
 4. Measure A increases the number of parks and amount of open space.  
 5. Measure A significantly enlarges and enhances Bidwell Park.  
 6. Approval of Measure A will require dedication of 130.8 acres to Bidwell Park.  
 7. Approval of Measure A will require the developer to dedicate seven park sites.  
 8. Approval of Measure A will create 53 acres of landscaped corridors and greenways.  
 9. Approval of Measure A will preserve existing arroyos and protect sensitive plant habitats....  
 10. Approval of Measure A will create junior high school and church sites.  
 11. Approval of Measure A will plan villages with 2,927 dwellings.  
 12. Approval of Measure A will provide onsite job opportunities and retail services.  
 13. [Unstated conclusion:] You should vote for Measure A.

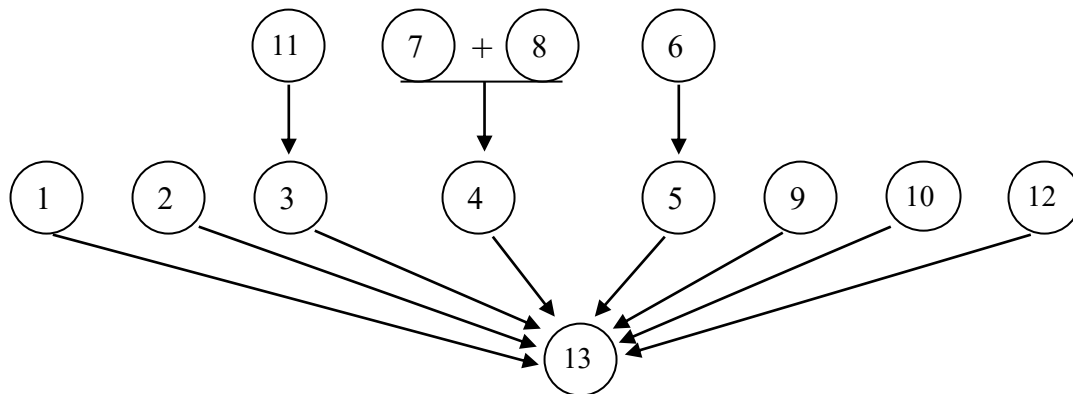

15. 1. A project with 3,000 houses and 7,000 new residents cannot properly be called a “village.”  
 2. Citizens of Chico will be better off if they vote no on Measure A. [Vote no on Measure A.]  
 3. The project will not protect agricultural land.  
 4. The Greenline protects valuable farmland.  
 5. With the Greenline, there is enough land in the Chico area available to build 62,000 new homes.  
 6. The project’s park dedications will not reduce use of Bidwell Park.  
 7. The developers want to attract 7,000 new residents [who will use the park].  
 8. The developers will not provide a school site [without cost to the taxpayers].  
 9. The developers intend to sell the site to the school district, which will pay for it with taxpayers’ money.

*One could include the claim “Chico does not need the Rancho Arroyo project” as the conclusion of a subargument—in the place of claim 2 in the diagram—and let it support*

*the final conclusion: One should vote against Measure A. (Chapter 12 discusses getting “ought” conclusions from “is” premises—we won’t complicate the example here by introducing an additional premise.) See next page for diagram.*

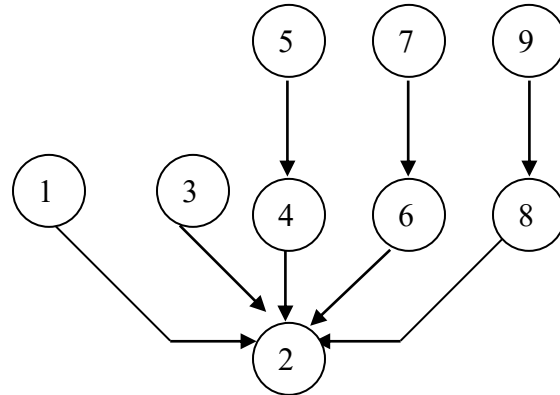

16. 1. I read about a murderer who was released from prison and killed someone.
2. I cannot understand how our justice system allows this to happen (i.e. this shouldn't happen).
3. According to FBI statistics, there is a murder every half hour.
4. Too many of these murders are committed by people who have been released from prison.
5. The main reason murderers are released from prison is the prisons can't hold them all.
6. If there is a murder every half hour there should be an execution every half hour.
7. This would open up room in prisons, allowing more killers to be kept off the streets.
8. We'd all be safe as a result.
9. It isn't like the people I'm saying should be executed don't deserve to die.
10. They gave up their right to live when they committed their crime.
11. We must get tough about this or none of us will be safe.

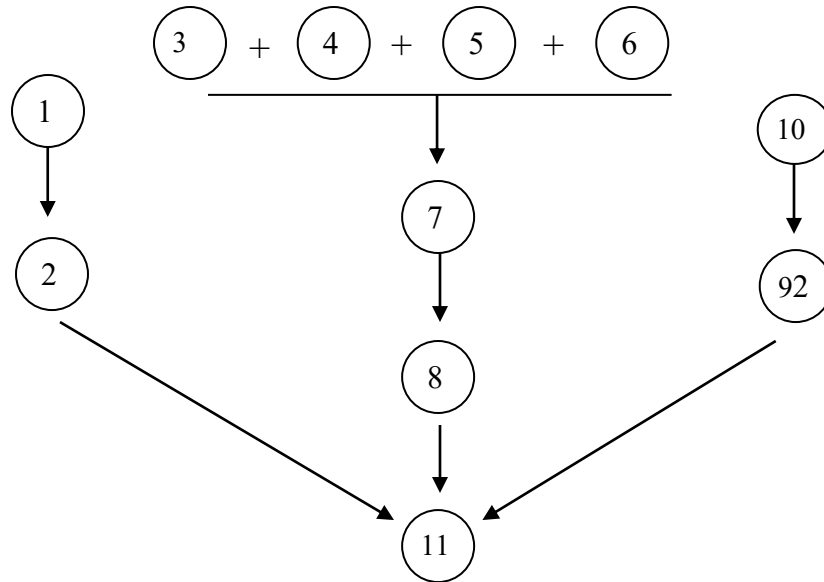

- ▲17. 1. In regard to your editorial, “Crime bill wastes billions,” let me set you straight. [Your position is mistaken.]  
 2. Your paper opposes mandatory life sentences for criminals convicted of three violent crimes, and you whine about how criminals’ rights might be violated.  
 3. Yet you also want to infringe on a citizen’s rights to keep and bear arms.  
 4. You say you oppose life sentences for three-time losers because judges couldn’t show any leniency toward the criminals no matter how trivial the crime.  
 5. What is your definition of trivial, busting an innocent child’s skull with a hammer?

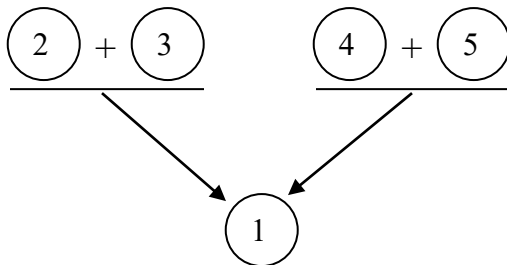

- ▲18. 1. Freedom means choice.  
 2. This is a truth:antiporn activists always forget when they argue for censorship.  
 3. In their fervor to impose their morality, groups like Enough Is Enough cite extreme examples of pornography, such as child porn, suggesting that they are available in video stores.  
 4. This is not the way it is.  
 5. Most of this material portrays not actions such as this but consensual sex between adults.  
 6. The logic used by Enough Is Enough is that, if something can somehow hurt someone,



it must be banned.

7. They don't apply this logic to more harmful substances such as alcohol or tobacco.

8. Women and children are more adversely affected by drunken driving and secondhand smoke than by pornography.

9. Few Americans would want to ban alcohol or tobacco even though these substances kill hundreds of thousands of people each year.

10. [Unstated conclusion] Enough Is Enough is inconsistent.

11. [Unstated conclusion] Enough Is Enough's antiporn position is incorrect.

