

MULTIPLE CHOICE. Choose the one alternative that best completes the statement or answers the question.

Solve the problem.

- 1) In an eye color study, 25 out of 50 people in the sample had brown eyes. In this situation, what does the number .50 represent?
- A) a class relative frequency
 - B) a class
 - C) a class percentage
 - D) a class frequency

Answer: A

- 2) What class percentage corresponds to a class relative frequency of .37?
- A) 63%
 - B) .63%
 - C) .37%
 - D) 37%

Answer: D

SHORT ANSWER. Write the word or phrase that best completes each statement or answers the question.

- 3) A sample of 100 e-mail users were asked whether their primary e-mail account was a free account, an institutional (school or work) account, or an account that they pay for personally. Identify the classes for the resulting data.

Answer: free account, institutional account, account paid for personally

MULTIPLE CHOICE. Choose the one alternative that best completes the statement or answers the question.

- 4) What number is missing from the table?

Grades on Test	Frequency	Relative Frequency
A	6	.24
B	7	
C	9	.36
D	2	.08
F	1	.04

- A) .28
- B) .70
- C) .07
- D) .72

Answer: A

5) What number is missing from the table?

Year in College	Frequency	Relative Frequency
Freshman	600	.30
Sophomore	560	.28
Junior		.22
Senior	400	.20

- A) 480
- B) 440
- C) 220
- D) 520

Answer: B

SHORT ANSWER. Write the word or phrase that best completes each statement or answers the question.

6) Complete the frequency table for the data shown below.

green blue brown orange blue
brown orange blue red green
blue brown green red brown
blue brown blue blue red

Color	Frequency
Green	
Blue	
Brown	
Orange	

Answer:

Color	Frequency
Green	3
Blue	7
Brown	5
Orange	2
Red	3

MULTIPLE CHOICE. Choose the one alternative that best completes the statement or answers the question.

Answer the question True or False.

7) A frequency table displays the proportion of observations falling into each class.

- A) True
- B) False

Answer: B

Solve the problem.

- 8) 260 randomly sampled college students were asked, among other things, to state their year in school (freshman, sophomore, junior, or senior). The responses are shown in the bar graph below. How many of the students who responded would be classified as upperclassmen (e.g., juniors or seniors)?

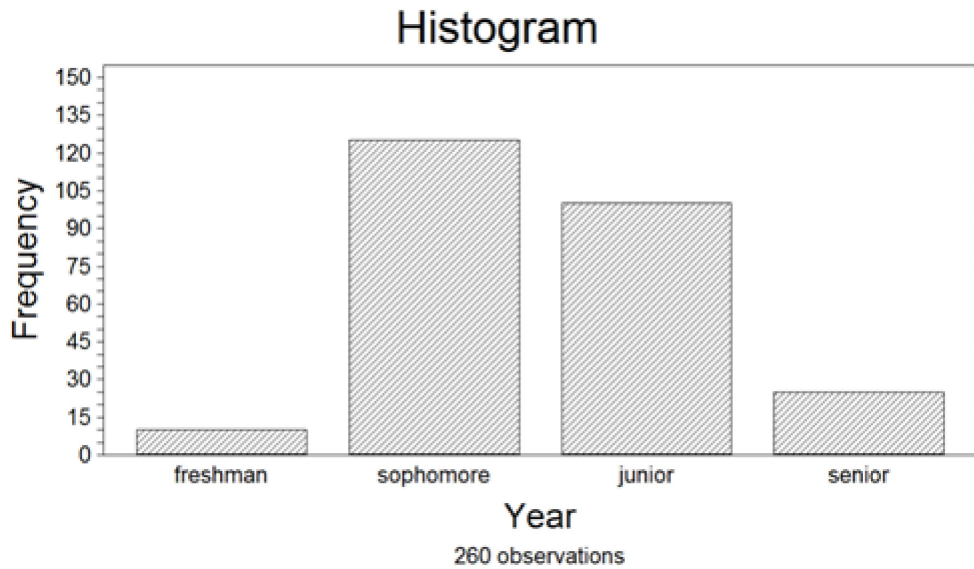

- A) Approximately 10
- B) Approximately 100
- C) Approximately 25
- D) Approximately 125

Answer: D

9)



The manager of a store conducted a customer survey to determine why customers shopped at the store. The results are shown in the figure. What proportion of customers responded that merchandise was the reason they shopped at the store?

A) 30

B) $\frac{2}{7}$

C) $\frac{1}{2}$

D) $\frac{3}{7}$

Answer: D

10)

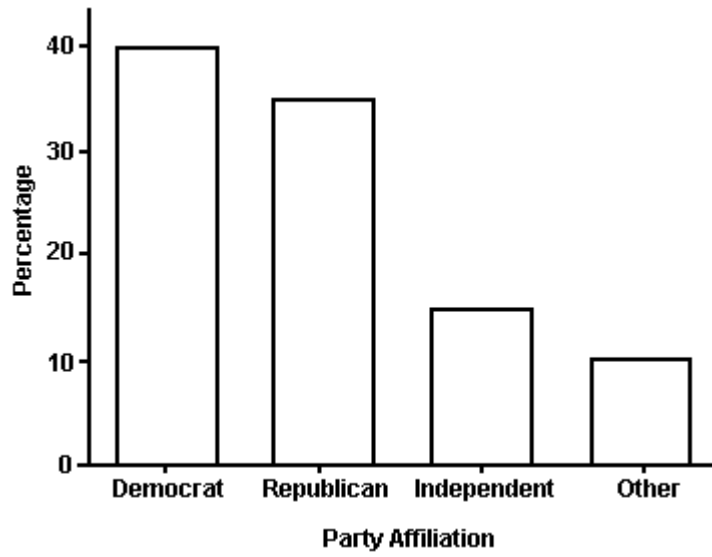

The bar graph shows the political affiliation of 1000 registered U.S. voters. What percentage of the voters belonged to one of the traditional two parties (Democratic or Republican)?

- A) 35%
- B) 25%
- C) 75%
- D) 40%

Answer: C

SHORT ANSWER. Write the word or phrase that best completes each statement or answers the question.

11) The data below show the types of medals won by athletes representing the United States in the Winter Olympics.

gold gold silver gold bronze silver silver
 bronze gold silver silver bronze silver gold
 gold silver silver bronze bronze gold silver
 gold gold bronze bronze

- Construct a frequency table for the data.
- Construct a relative frequency table for the data.
- Construct a frequency bar graph for the data.

Answer: a.

Medal	Frequency
Gold	9
Silver	9
Bronze	7

b.

Medal	Relative Frequency
Gold	.36
Silver	.36
Bronze	.28

c.

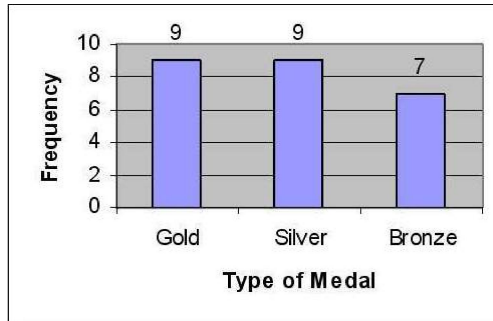

MULTIPLE CHOICE. Choose the one alternative that best completes the statement or answers the question.

Answer the question True or False.

12) The bars in a bar graph can be arranged by height in ascending order from left to right.

- True
- False

Answer: A

13) Either vertical or horizontal bars can be used when constructing a bar graph.

- True
- False

Answer: A

Solve the problem.

14)

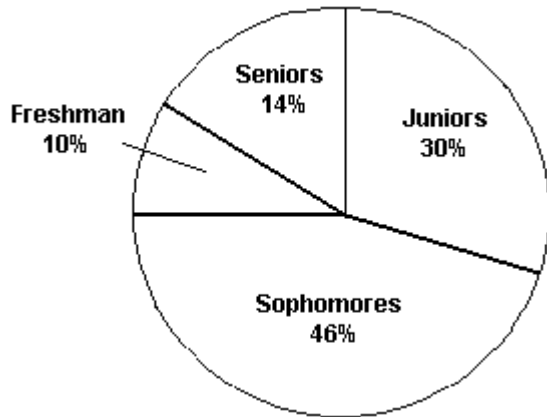

The pie chart shows the classifications of students in a statistics class.

What percentage of the class consists of freshman, sophomores, and juniors?

- A) 44%
- B) 86%
- C) 54%
- D) 14%

Answer: B

15) One of the questions posed to a sample of 286 incoming freshmen at a large public university was, "Do you have any tattoos?" Their responses are shown below in the pie chart. Please note that the values shown represent the number of responses in each category.

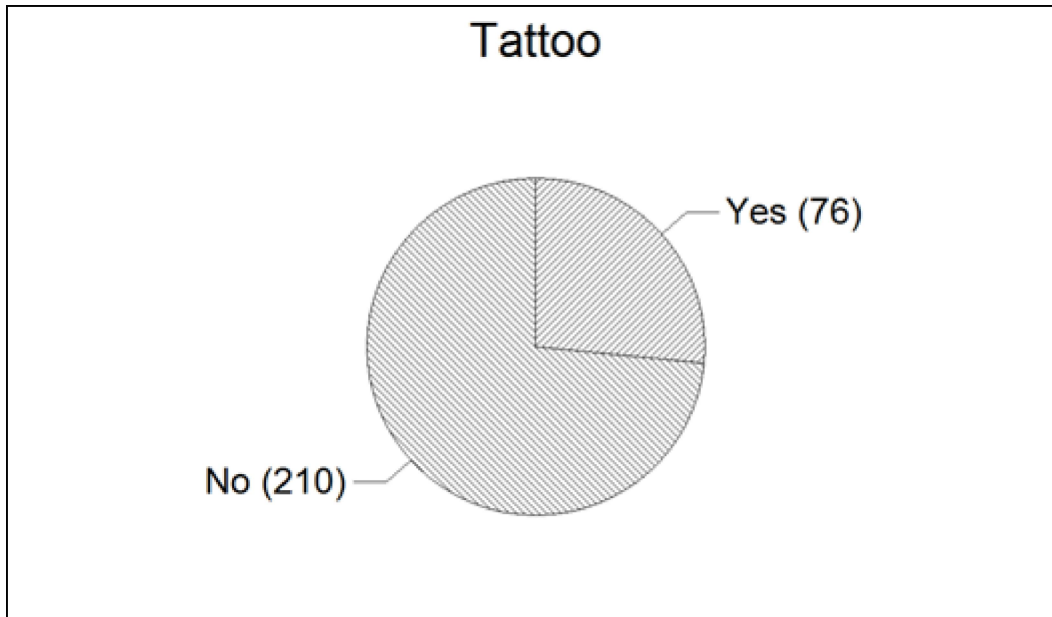

Based on the responses shown in the pie chart, what percentage of the freshmen responded with "Yes?"

- A) 76%
- B) 73.4%
- C) 26.6%
- D) 76

Answer: C

SHORT ANSWER. Write the word or phrase that best completes each statement or answers the question.

16) The table shows the number of each type of book found at an online auction site during a recent search.

Type of Book	Number
Children's	51,033
Fiction	141,114
Nonfiction	253,074
Educational	67,252

- Construct a relative frequency table for the book data.
- Construct a pie chart for the book data.

Answer: a.

Type of Book	Relative Frequency
Children's	.10
Fiction	.28
Nonfiction	.49
Educational	.13

b.

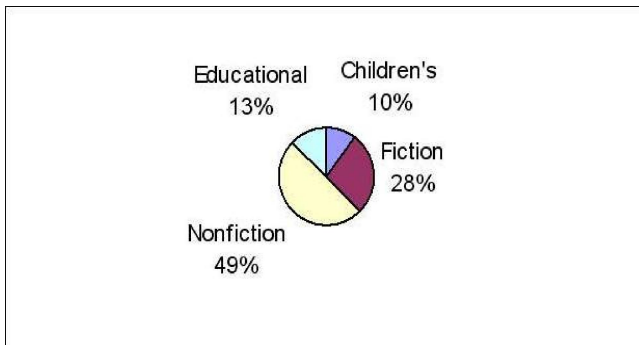

MULTIPLE CHOICE. Choose the one alternative that best completes the statement or answers the question.

Answer the question True or False.

17) If 25% of your statistics class is sophomores, then in a pie chart representing classifications of the students in your statistics class the slice assigned to sophomores is 90° .

- True
- False

Answer: A

18) The slices of a pie chart must be arranged from largest to smallest in a clockwise direction.

- True
- False

Answer: B

SHORT ANSWER. Write the word or phrase that best completes each statement or answers the question.

Solve the problem.

19) What characteristic of a Pareto diagram distinguishes it from other bar graphs?

Answer: In a Pareto diagram, the bars are arranged by height in a descending order from left to right.

20) The table shows the number of each type of car sold in June.

Car	Number
compact	7,204
sedan	9,089
small SUV	20,418
large SUV	13,691
minivan	15,837
truck	15,350
Total	81,589

a. Construct a relative frequency table for the car sales.

b. Construct a Pareto diagram for the car sales using the class percentages as the heights of the bars.

Answer: a.

Car	Relative Frequency
compact	0.09
sedan	0.11
small SUV	0.25
large SUV	0.17
minivan	0.19
truck	0.19

b.

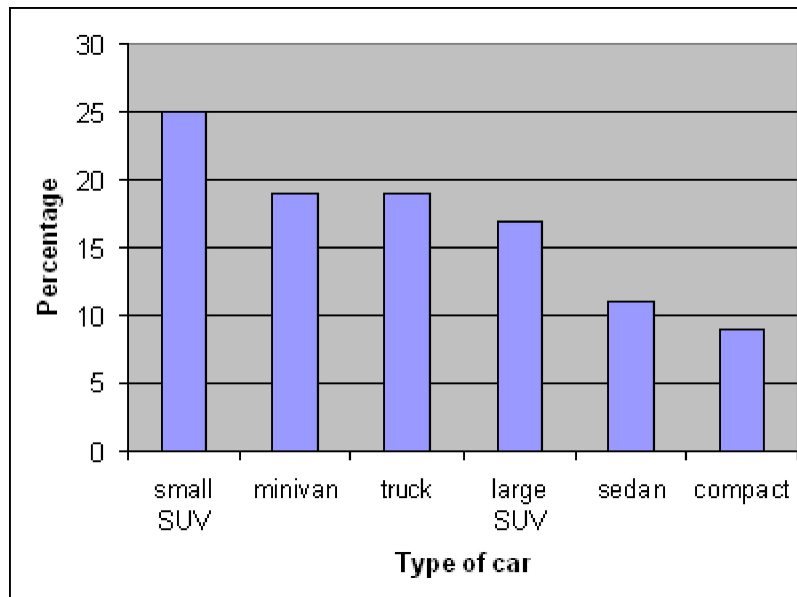

MULTIPLE CHOICE. Choose the one alternative that best completes the statement or answers the question.

Answer the question True or False.

21) Class relative frequencies must be used, rather than class frequencies or class percentages, when constructing a Pareto diagram.

- A) True
- B) False

Answer: B

22) A Pareto diagram is a pie chart where the slices are arranged from largest to smallest in a counterclockwise direction.

- A) True
- B) False

Answer: B

SHORT ANSWER. Write the word or phrase that best completes each statement or answers the question.

Solve the problem.

23) An annual survey sent to retail store managers contained the question "Did your store suffer any losses due to employee theft?" The responses are summarized in the table for two years. Compare the responses for the two years using side-by-side bar charts. What inferences can be made from the charts?

Employee Theft	Percentage in year 1	Percentage in year 2
Yes	34	23
No	51	68
Don't know	15	9
Totals	100	100

Answer:

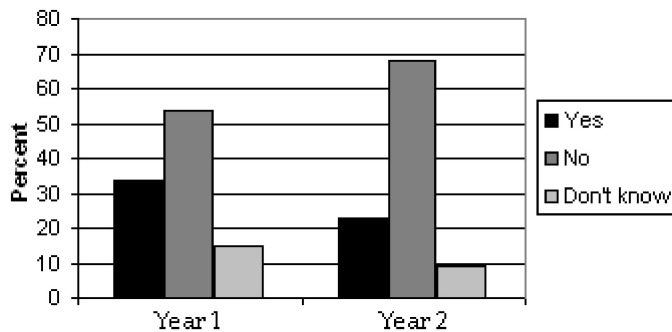

Losses due to employee theft have decreased from year 1 to year 2.

MULTIPLE CHOICE. Choose the one alternative that best completes the statement or answers the question.

24) The payroll amounts for all teams in an international hockey league are shown below using a graphical technique from chapter 2 of the text. How many of the hockey team payrolls exceeded \$20 million (Note: Assume that no payroll was exactly \$20 million)?

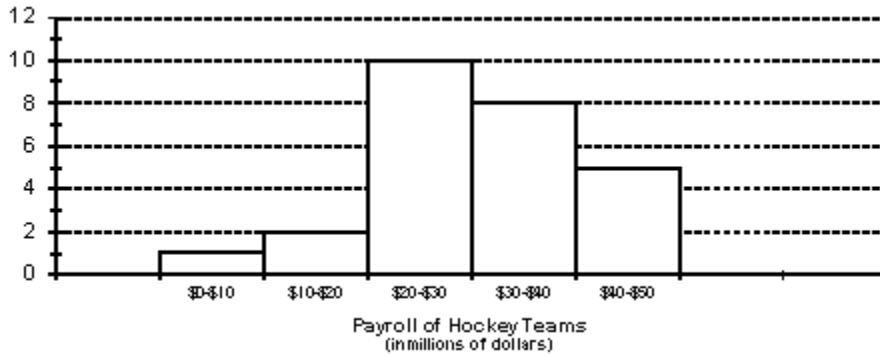

- A) 23 teams
- B) 18 teams
- C) 8 teams
- D) 10 teams

Answer: A

SHORT ANSWER. Write the word or phrase that best completes each statement or answers the question.

25) The data show the total number of medals (gold, silver, and bronze) won by each country winning at least one gold medal in the Winter Olympics.

- 1 2 3 3 4 9 9 11 11
 11 14 14 19 22 23 24 25 29

a. Complete the class frequency table for the data.

Total Medals	Frequency
1-5	
6-10	
11-15	
16-20	
21-25	
26-30	

b. Using the classes from the frequency table, construct a histogram for the data.

Answer: a.

Total Medals	Frequency
1-5	5
6-10	2
11-15	5
16-20	1
21-25	4
26-30	1

b.

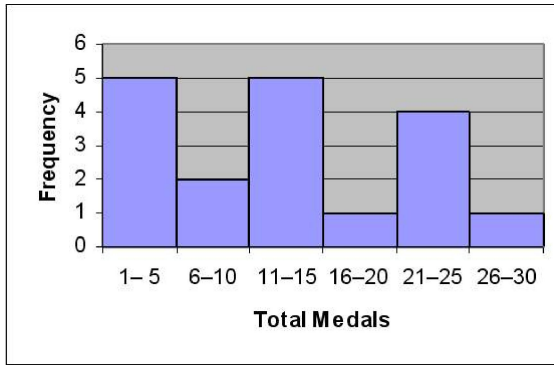

26) The total points scored by a basketball team for each game during its last season have been summarized in the table below.

Score	Frequency
41-60	3
61-80	8
81-100	12
101-120	7

- Explain why you cannot use the information in the table to construct a stem-and-leaf display for the data.
- Construct a histogram for the scores.

Answer: a. The exact scores would be needed to construct a stem-and-leaf display but the exact scores are not available in the table given.

b.

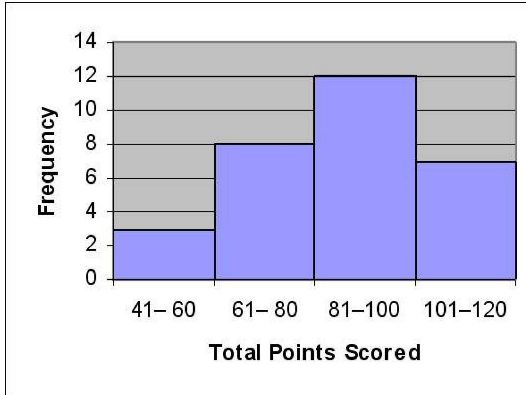

MULTIPLE CHOICE. Choose the one alternative that best completes the statement or answers the question.

Answer the question True or False.

27) All class intervals in a histogram have the same width.

- True
- False

Answer: A

- 28) A histogram can be constructed using either class frequencies or class relative frequencies as the heights of the bars.
- A) True
 - B) False

Answer: A

- 29) The bars in a histogram should be arranged by height in descending order from left to right.
- A) True
 - B) False

Answer: B

Solve the problem.

- 30) A survey was conducted to determine how people feel about the quality of programming available on television. Respondents were asked to rate the overall quality from 0 (no quality at all) to 100 (extremely good quality). The stem-and-leaf display of the data is shown below.

Stem	Leaf
3	1 2
4	0 3 4 7 8 9 9 9
5	0 1 1 2 3 4 5
6	1 2 5 6 6
7	1 2
8	
9	7

What percentage of the respondents rated overall television quality as very good (regarded as ratings of 80 and above)?

- A) 1%
- B) 7%
- C) 28%
- D) 4%

Answer: D

- 31) 252 randomly sampled college students were asked, among other things, to estimate their college grade point average (GPA). The responses are shown in the stem-and-leaf plot shown below. Notice that a GPA of 3.65 would be indicated with a stem of 36 and a leaf of 5 in the plot. How many of the students who responded had GPA's that exceeded 3.55?

Stem and Leaf Plot of GPA

Leaf Digit Unit = 0.01
 19 9 represents 1.99

Minimum 1.9900
 Median 3.1050
 Maximum 4.0000

	Stem	Leaves
1	19	9
5	20	0668
6	21	0
11	22	05567
15	23	0113
20	24	00005
33	25	0000000000067
46	26	000005577789
61	27	00000134455578
79	28	00000000144667799
88	29	002356777
116	30	0000000000000000011344559
(19)	31	000000000112235666
117	32	000000000000000345568
95	33	00000000025557
80	34	000000000000000333444566677889
49	35	000003355566677899
31	36	000005
25	37	022235588899
13	38	00002579
5	39	7
4	40	0000

252 cases included

- A) 49
- B) 31
- C) 39
- D) 19

Answer: C

SHORT ANSWER. Write the word or phrase that best completes each statement or answers the question.

32) The scores for a statistics test are as follows:

87 76 91 77 94 94 88 85 66 89
79 97 56 98 83 88 82 57 14 69

Create a stem-and-leaf display for the data.

Answer:

Stem	Leaf
1	4
2	
3	
4	
5	6 7
6	6 9
7	6 7 9
8	2 3 5 7 8 8 9
9	1 4 4 7 8

MULTIPLE CHOICE. Choose the one alternative that best completes the statement or answers the question.

Answer the question True or False.

33) For large data sets, a stem-and-leaf display is a better choice than a histogram.

- A) True
- B) False

Answer: B

Solve the problem.

34) A dot plot of the speeds of a sample of 50 cars passing a policeman with a radar gun is shown below.

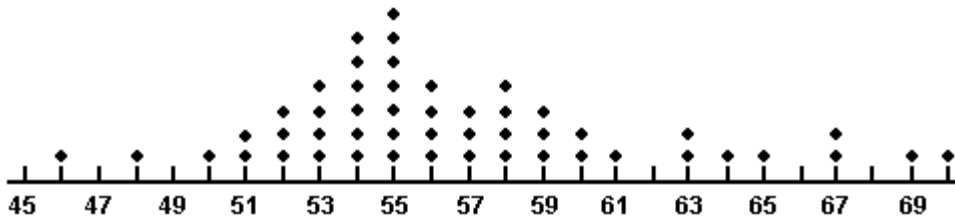

What proportion of the motorists were driving above the posted speed limit of 55 miles per hour?

- A) 0.14
- B) 7
- C) 0.64
- D) 0.50

Answer: D

35) Which of the graphical techniques below can be used to summarize qualitative data?

- A) stem-and-leaf plot
- B) bar graph
- C) dot plot
- D) box plot

Answer: B

36) Parking at a university has become a problem. University administrators are interested in determining the average time it takes a student to find a parking spot. An administrator inconspicuously followed 250 students and recorded how long it took each of them to find a parking spot. Which of the following types of graphs should not be used to display information concerning the students parking times?

- A) box plot
- B) stem-and-leaf display
- C) pie chart
- D) histogram

Answer: C

37) Fill in the blank. One advantage of the _____ is that the actual data values are retained in the graphical summarization of the data.

- A) histogram
- B) pie chart
- C) stem-and-leaf plot

Answer: C

- 38) The amount spent on textbooks for the fall term was recorded for a sample of five university students – \$400, \$350, \$600, \$525, and \$450. Calculate the value of the sample mean for the data.
- A) \$465
 - B) \$600
 - C) \$450
 - D) \$400

Answer: A

- 39) The amount spent on textbooks for the fall term was recorded for a sample of five university students – \$400, \$350, \$600, \$525, and \$450. Calculate the value of the sample median for the data.
- A) \$450
 - B) \$400
 - C) \$465
 - D) \$600

Answer: A

- 40) A sociologist recently conducted a survey of senior citizens who have net worths too high to qualify for Medicaid but have no private health insurance. The ages of the 25 uninsured senior citizens were as follows:

69	74	67	77	87
75	62	90	66	91
70	93	77	63	82
64	69	82	71	74
61	88	76	65	83

Find the median of the observations.

- A) 74
- B) 74.5
- C) 71
- D) 75

Answer: A

- 41) The scores for a statistics test are as follows:

87	76	84	77	97	92	73	85	69	89
79	61	50	95	85	77	85	65	18	93

Compute the mean score.

- A) 67.80
- B) 76.85
- C) 80.05
- D) 75

Answer: B

42) A shoe retailer keeps track of all types of information about sales of newly released shoe styles. One newly released style was marketed to tall people. Listed below are the shoe sizes of 12 randomly selected customers who purchased the new style. Find the mode of the shoe sizes.

$9\frac{1}{2}$	11	12	$11\frac{1}{2}$
$8\frac{1}{2}$	$10\frac{1}{2}$	8	11
10	11	$9\frac{1}{2}$	10

- A) 11
- B) $9\frac{1}{2}$
- C) $10\frac{1}{2}$
- D) $10\frac{1}{4}$

Answer: A

SHORT ANSWER. Write the word or phrase that best completes each statement or answers the question.

43) Each year advertisers spend billions of dollars purchasing commercial time on network television. In the first 6 months of one year, advertisers spent \$1.1 billion. Who were the largest spenders? In a recent article, the top 10 leading spenders and how much each spent (in million of dollars) were listed:

Company A	\$72.2	Company F	\$26.7
Company B	63.9	Company G	25.7
Company C	55	Company H	21.7
Company D	54	Company I	21.9
Company E	28.7	Company J	19.8

Calculate the mean and median for the data.

Answer: The mean of the data is $x = \frac{\sum x}{n}$

$$\begin{aligned} & \frac{72.2 + 63.9 + 55 + 54 + 28.7 + 26.7 + 25.7 + 21.7 + 21.9 + 19.8}{10} \\ &= \frac{389.6}{10} \\ &= 38.96 \Rightarrow \$38.96 \text{ million} \end{aligned}$$

The median is the average of the middle two observations.

$$M = \frac{28.7 + 26.7}{2} = 27.70 \Rightarrow \$27.70 \text{ million}$$

44) The data show the total number of medals (gold, silver, and bronze) won by each country winning at least one gold medal in the Winter Olympics. Find the mean, median, and mode of the numbers of medals won by these countries.

1 2 3 3 4 9 9 11 11
 11 14 14 19 22 23 24 25 29

Answer: The mean is the sum of the numbers divided by 18:

$$\frac{1 + 2 + 3 + 3 + 4 + 9 + 9 + 11 + 11 + 11 + 14 + 14 + 19 + 22 + 23 + 24 + 25 + 29}{18}$$

$$= \frac{234}{18} = 13 \text{ medals.}$$

The median is the mean of the two middle numbers: $\frac{11 + 11}{2} = 11$ medals.

The mode is the most frequent number of medals: 11 medals.

45) Calculate the mean of a sample for which $\sum x = 196$ and $n = 8$.

Answer: The mean is divided by n:

$$\frac{\sum x}{n} = \frac{196}{8} = 24.5.$$

46) The calculator screens summarize a data set.

```

1-Var Stats
x̄=79.95238095
Σx=1679
Σx²=138471
Sx=14.54467666
σx=14.19415101
↓n=21
  
```

```

1-Var Stats
↑n=21
minX=30
Q1=75
Med=82
Q3=90
maxX=97
  
```

- How many data items are in the set?
- What is the sum of the data?
- Identify the mean, median, and mode, if possible.

Answer: a. $n = 21$

b. $\sum x = 1679$

c. mean: $\bar{x} \approx 79.95$; median: Med=82; mode: not possible

MULTIPLE CHOICE. Choose the one alternative that best completes the statement or answers the question.

- 47) At the U.S. Open Tennis Championship a statistician keeps track of every serve that a player hits during the tournament. The statistician reported that the mean serve speed of a particular player was 104 miles per hour. Suppose that the statistician indicated that the serve speed distribution was skewed to the left. Which of the following values is most likely the value of the median serve speed?
- A) 104 mph
 - B) 112 mph
 - C) 88 mph
 - D) 96 mph

Answer: B

- 48) The amount spent on textbooks for the fall term was recorded for a sample of five hundred university students. The mean expenditure was calculated to be \$500 and the median expenditure was calculated to be \$425. Which of the following interpretations of the mean is correct?
- A) 50% of the students sampled had textbook costs that were less than \$500
 - B) The most frequently occurring textbook cost in the sample was \$500
 - C) 50% of the students sampled had textbook costs equal to \$500
 - D) The average of the textbook costs sampled was \$500

Answer: D

- 49) The amount spent on textbooks for the fall term was recorded for a sample of five hundred university students. The mean expenditure was calculated to be \$500 and the median expenditure was calculated to be \$425. Which of the following interpretations of the median is correct?
- A) The average of the textbook costs sampled was \$425
 - B) 50% of the students sampled had textbook costs equal to \$425
 - C) The most frequently occurring textbook cost in the sample was \$425
 - D) 50% of the students sampled had textbook costs that were less than \$425

Answer: D

- 50) During one recent year, U.S. consumers redeemed 6.31 billion manufacturers' coupons and saved themselves \$2.56 billion. Calculate and interpret the mean savings per coupon.
- A) The average savings was 246.5 cents per coupon.
 - B) Half of all coupons were worth more than 246.5 cents in savings.
 - C) Half of all coupons were worth more than \$0.41 in savings.
 - D) The average savings was \$0.41 per coupon.

Answer: D

- 51) The output below displays the mean and median for the state high school dropout rates in year 1 and in year 5.

	Year 1	Year 5
N	51	51
MEAN	28.52	26.17
MEDIAN	27.04	25.43

Interpret the year 5 median dropout rate of 25.43.

- A) Half of the 51 states had a dropout rate below 25.43%.
- B) The most frequently observed dropout rate of the 51 states was 25.43%.
- C) Most of the 51 states had a dropout rate close to 25.43%.
- D) Half of the 51 states had a dropout rate of 25.43%.

Answer: A

52)

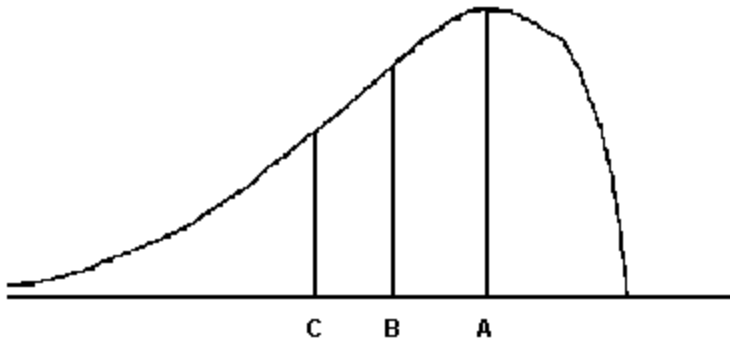

For the distribution drawn here, identify the mean, median, and mode.

- A) A = mean, B = mode, C = median
- B) A = mode, B = mean, C = median
- C) A = mode, B = median, C = mean
- D) A = median, B = mode, C = mean

Answer: C

53) In a distribution that is skewed to the right, what is the relationship of the mean, median, and mode?

- A) mode > median > mode
- B) median > mean > mode
- C) mode > mean > median
- D) mean > median > mode

Answer: D

54) Many firms use on-the-job training to teach their employees computer programming. Suppose you work in the personnel department of a firm that just finished training a group of its employees to program, and you have been requested to review the performance of one of the trainees on the final test that was given to all trainees. The mean of the test scores is 79. Additional information indicated that the median of the test scores was 89. What type of distribution most likely describes the shape of the test scores?

- A) skewed to the right
- B) symmetric
- C) skewed to the left
- D) unable to determine with the information given

Answer: C

55) A shoe company reports the mode for the shoe sizes of men's shoes is 12. Interpret this result.

- A) Half of the shoes sold to men are larger than a size 12
- B) Half of all men's shoe sizes are size 12
- C) The most frequently occurring shoe size for men is size 12
- D) Most men have shoe sizes between 11 and 13.

Answer: C

56) Which of the following is *not* a measure of central tendency?

- A) mode
- B) mean
- C) median
- D) range

Answer: D

- 57) The distribution of salaries of professional basketball players is skewed to the right. Which measure of central tendency would be the best measure to determine the location of the center of the distribution?
- A) median
 - B) mean
 - C) range
 - D) mode

Answer: A

SHORT ANSWER. Write the word or phrase that best completes each statement or answers the question.

- 58) Parking at a university has become a problem. University administrators are interested in determining the average time it takes a student to find a parking spot. An administrator inconspicuously followed 190 students and recorded how long it took each of them to find a parking spot. The times had a distribution that was skewed to the left. Based on this information, discuss the relationship between the mean and the median for the 190 times collected.

Answer: Since the distribution is skewed to the left, we know that the median time will exceed the mean time.

- 59) The output below displays the mean and median for the state high school dropout rates in year 1 and in year 5.

	Year 1	Year 5
N	51	51
MEAN	28.56	26.35
MEDIAN	27.11	25.39

Use the information to determine the shape of the distributions of the high school dropout rates in year 1 and year 5.

Answer: In both year 1 and year 5, the mean dropout rates exceed the median dropout rates. This indicates that both the year 1 and year 5 high school dropout rates have distributions that are skewed to the right.

- 60) The total points scored by a basketball team for each game during its last season have been summarized in the table below. Identify the modal class of the distribution of scores.

Score	Frequency
41-60	3
61-80	8
81-100	12
101-120	7

Answer: The modal class is the class with the greatest frequency: 81-100 points.

61) The calculator screens summarize a data set.

```
1-Var Stats
x̄=73.65217391
Σx=1694
Σx²=138696
Sx=25.16239744
σx=24.60931018
↓n=23
```

```
1-Var Stats
↑n=23
minX=0
Q1=73
Med=81
Q3=90
maxX=97
```

- Identify the mean and the median.
- Based only on the mean and the median, do you expect that the data set is skewed to the right, symmetric, or skewed to the left? Explain.

Answer: a. mean: $\bar{x} \approx 73.65$; median: Med=81

- We expect the data to be skewed to the left because the mean is less than the median.

MULTIPLE CHOICE. Choose the one alternative that best completes the statement or answers the question.

Answer the question True or False.

62) The mean and the median are useful measures of central tendency for both qualitative and quantitative data.

- True
- False

Answer: B

63) In a symmetric and mound shaped distribution, we expect the values of the mean, median, and mode to differ greatly from one another.

- True
- False

Answer: B

64) In symmetric distributions, the mean and the median will be approximately equal.

- True
- False

Answer: A

65) In skewed distributions, the mean is the best measure of the center of the distribution since it is least affected by extreme observations.

- True
- False

Answer: B

66) In practice, the population mean μ is used to estimate the sample mean \bar{x} .

- True
- False

Answer: B

67) In general, the sample mean is a better estimator of the population mean for larger sample sizes.

- True
- False

Answer: A

Solve the problem.

68) Each year advertisers spend billions of dollars purchasing commercial time on network television. In the first 6 months of one year, advertisers spent \$1.1 billion. Who were the largest spenders? In a recent article, the top 10 leading spenders and how much each spent (in million of dollars) were listed:

Company A	\$73.1	Company F	\$26.7
Company B	63.4	Company G	24.4
Company C	57.1	Company H	21.6
Company D	55.6	Company I	23.8
Company E	30.3	Company J	20.8

Calculate the sample variance.

- A) 3905.772
- B) 2160.733
- C) 406.877
- D) 1936.283

Answer: C

69) Calculate the range of the following data set:

8, 9, 9, 2, 6, 13, 9, 7, 4

- A) 15
- B) 2
- C) 11
- D) 13

Answer: C

70) The top speeds for a sample of five new automobiles are listed below. Calculate the standard deviation of the speeds. Round to four decimal places.

200, 105, 100, 190, 160

- A) 136.03
- B) 175.0528
- C) 243.2745
- D) 46.6905

Answer: D

71) The amount spent on textbooks for the fall term was recorded for a sample of five university students - \$400, \$350, \$600, \$525, and \$450. Calculate the value of the sample range for the data.

- A) \$450
- B) \$99.37
- C) \$98.75
- D) \$250

Answer: D

- 72) The amount spent on textbooks for the fall term was recorded for a sample of five university students – \$400, \$350, \$600, \$525, and \$450. Calculate the value of the sample standard deviation for the data.
- A) \$98.75
 - B) \$450
 - C) \$99.37
 - D) \$250

Answer: C

SHORT ANSWER. Write the word or phrase that best completes each statement or answers the question.

- 73) The ages of five randomly chosen professors are 42, 55, 45, 51, and 59. Calculate the sample variance of these ages.

Answer: $s^2 = \frac{\sum(x - \bar{x})^2}{n - 1}$

$$\bar{x} = \frac{\sum x}{n} = \frac{42 + 55 + 45 + 51 + 59}{5} = 50.4$$

$$s^2 = \frac{(42 - 50.4)^2 + (55 - 50.4)^2 + (45 - 50.4)^2 + (51 - 50.4)^2 + (59 - 50.4)^2}{5 - 1}$$

$$= 48.80$$

- 74) The data show the total number of medals (gold, silver, and bronze) won by each country winning at least one gold medal in the Winter Olympics. Find the range, sample variance, and sample standard deviation of the numbers of medals won by these countries.

1 2 3 3 4 9 9 11 11
 11 14 14 19 22 23 24 25 29

Answer: The range is $29 - 1 = 28$ medals.

The variance is $s^2 = \frac{\sum x^2 - \frac{(\sum x)^2}{n}}{n - 1} = \frac{4372 - \frac{(234)^2}{18}}{17} = \frac{1330}{17} \approx 78.24$

The standard deviation is $s = \sqrt{s^2} = \sqrt{\frac{1330}{17}} \approx 8.85$

75) The calculator screens summarize a data set.

```
1-Var Stats
x̄=79.95238095
Σx=1679
Σx²=138471
Sx=14.54467666
σx=14.19415101
↓n=21
```

```
1-Var Stats
↑n=21
minX=30
Q1=75
Med=82
Q3=90
maxX=97
```

- Identify the smallest measurement in the data set.
- Identify the largest measurement in the data set.
- Calculate the range of the data set.

Answer: a. minX=30
b. maxX=97
c. $97 - 30 = 67$

MULTIPLE CHOICE. Choose the one alternative that best completes the statement or answers the question.

76) Calculate the variance of a sample for which $n = 5$, $\sum x^2 = 1320$, $\sum x = 80$.

- 3.16
- 8.00
- 326.00
- 10.00

Answer: D

77) Calculate the standard deviation of a sample for which $n = 6$, $\sum x^2 = 830$, $\sum x = 60$.

- 46.00
- 6.19
- 6.78
- 164.00

Answer: C

78) Compute s^2 and s for the data set: -3, 1, -3, -3, 1, -3

- 3; 1.73
- 4.27; 2.07
- 3.6; 1.9
- 18.73; 4.33

Answer: B

79) Compute s^2 and s for the data set: $\frac{4}{5}, \frac{2}{5}, \frac{4}{5}, \frac{1}{5}, \frac{3}{5}, \frac{1}{10}$.

- 0.028; 0.167
- 1.62; 1.273
- 0.09; 0.299
- 8.967; 2.994

Answer: C

- 80) The range of scores on a statistics test was 42. The lowest score was 57. What was the highest score?
- A) 70.5
 - B) cannot be determined
 - C) 99
 - D) 78

Answer: C

- 81) The temperature fluctuated between a low of 73°F and a high of 89°F. Which of the following could be calculated using just this information?
- A) standard deviation
 - B) median
 - C) variance
 - D) range

Answer: D

- 82) Which of the following is a measure of the variability of a distribution?
- A) median
 - B) range
 - C) sample size
 - D) skewness

Answer: B

SHORT ANSWER. Write the word or phrase that best completes each statement or answers the question.

- 83) Various state and national automobile associations regularly survey gasoline stations to determine the current retail price of gasoline. Suppose one such national association contacts 200 stations in the United States to determine the price of regular unleaded gasoline at each station. In the context of this problem, define the following descriptive measures: μ , σ , \bar{x} , s .

Answer: μ is the mean price of the regular unleaded gasoline prices of all retail gas stations in the United States.

σ is the standard deviation of the regular unleaded gasoline prices of all retail gas stations in the United States.

\bar{x} is the mean price of the regular unleaded gasoline prices collected from the 200 stations sampled.

s is the standard deviation of the regular unleaded gasoline prices collected from the 200 stations sampled.

- 84) Given the sample variance of a distribution, explain how to find the standard deviation.

Answer: Take the square root of the sample variance to find the sample standard deviation.

- 85) Which is expressed in the same units as the original data, the variance or the standard deviation?

Answer: standard deviation

- 86) Which measures variability about the mean, the range or the standard deviation?

Answer: standard deviation

- 87) For a given data set, which is typically greater, the range or the standard deviation?

Answer: range

MULTIPLE CHOICE. Choose the one alternative that best completes the statement or answers the question.

- 88) The total points scored by a basketball team for each game during its last season have been summarized in the table below. Which statement following the table must be true?

Score	Frequency
41-60	3
61-80	8
81-100	12
101-120	7

- A) The range is 79.
- B) The range is at least 81 but at most 100.
- C) The range is at least 41 but at most 79.
- D) The range is at least 41 but at most 120.

Answer: C

- 89) Which number on the screen below is the sample standard deviation of the data?

```
1-Var Stats
x̄=5.8
Σx=58
Σx²=408
Sx=2.82055944
σx=2.675817632
↓n=10
```

- A) 408
- B) 5.8
- C) 2.82
- D) 2.67

Answer: C

Answer the question True or False.

- 90) The range is an insensitive measure of data variation for large data sets because two data sets can have the same range but be vastly different with respect to data variation.
- A) True
 - B) False

Answer: A

- 91) For any quantitative data set, $\sum(x - \bar{x}) = 0$.

- A) True
- B) False

Answer: A

- 92) The sample variance and standard deviation can be calculated using only the sum of the data, $\sum x$, and the sample size, n .

- A) True
- B) False

Answer: B

93) The sample variance is always greater than the sample standard deviation.

- A) True
- B) False

Answer: B

94) A larger standard deviation means greater variability in the data.

- A) True
- B) False

Answer: A

Solve the problem.

95) The mean \bar{x} of a data set is 36.71, and the sample standard deviation s is 3.22. Find the interval representing measurements within one standard deviation of the mean.

- A) (30.27, 43.15)
- B) (33.49, 39.93)
- C) (35.71, 37.71)
- D) (27.05, 46.37)

Answer: B

96) The following is a list of 25 measurements:

12 18 14 17 19 16 14 18 15 17 11
13 14 11 16 18 15 13 17 15 14 19
12 16 17

How many of the measurements fall within one standard deviation of the mean?

- A) 25
- B) 16
- C) 18
- D) 13

Answer: B

97) A standardized test has a mean score of 500 points with a standard deviation of 100 points. Five students' scores are shown below.

Adam: 575 Beth: 690 Carlos: 750 Doug: 280 Ella: 440

Which of the students have scores within two standard deviations of the mean?

- A) Adam, Beth, Carlos, Ella
- B) Carlos, Doug
- C) Adam, Beth, Ella
- D) Adam, Beth

Answer: C

SHORT ANSWER. Write the word or phrase that best completes each statement or answers the question.

98) The mean \bar{x} of a data set is 18, and the sample standard deviation s is 2. Explain what the interval (12, 24) represents.

Answer: measurements within three standard deviations of the mean

99) The calculator screens summarize a data set.

```
1-Var Stats
x̄=5.5
Σx=55
Σx²=385
Sx=3.027650354
σx=2.872281323
↓n=10
```

```
1-Var Stats
↑n=10
minX=1
Q1=3
Med=5.5
Q3=8
maxX=10
```

- Identify the mean and the sample standard deviation. Round to one place after the decimal, where necessary.
- Find the interval that corresponds to measurements within two standard deviations of the mean.

Answer: a. mean: $\bar{x} = 5.5$; sample standard deviation: $S_x \approx 3.0$

b. $(5.5 - 2 \times 3.0, 5.5 + 2 \times 3.0) = (-.5, 11.5)$

MULTIPLE CHOICE. Choose the one alternative that best completes the statement or answers the question.

- 100) At the U.S. Open Tennis Championship a statistician keeps track of every serve that a player hits during the tournament. The statistician reported that the mean serve speed was 100 miles per hour (mph) and the standard deviation of the serve speeds was 15 mph. Assume that the statistician also gave us the information that the distribution of serve speeds was mound-shaped and symmetric. What percentage of the player's serves were between 115 mph and 145 mph?
- at most 34%
 - approximately 16%
 - at most 2.5%
 - at most 13.5%

Answer: B

- 101) At the U.S. Open Tennis Championship a statistician keeps track of every serve that a player hits during the tournament. The statistician reported that the mean serve speed of a particular player was 104 miles per hour (mph) and the standard deviation of the serve speeds was 14 mph. Assume that the statistician also gave us the information that the distribution of the serve speeds was mound-shaped and symmetric. What proportion of the player's serves was between 118 mph and 132 mph?
- 0.95
 - 132
 - 0.270
 - 0.1350

Answer: D

- 102) The amount of time workers spend commuting to their jobs each day in a large metropolitan city has a mean of 70 minutes and a standard deviation of 20 minutes. Assuming the distribution of commuting times is known to be moundshaped and symmetric, what percentage of these commuting times are between 50 and 110 minutes?
- approximately 68%
 - approximately 97.5%
 - approximately 81.5%
 - approximately 95%

Answer: C

- 103) The amount of television viewed by today's youth is of primary concern to Parents Against Watching Television (PAWT). 300 parents of elementary school-aged children were asked to estimate the number of hours per week that their child watches television. The mean and the standard deviation for their responses were 18 and 5, respectively. PAWT constructed a stem-and-leaf display for the data that showed that the distribution of times was a symmetric, mound-shaped distribution. Give an interval where you believe approximately 95% of the television viewing times fell in the distribution.
- A) less than 28
 - B) between 3 and 33 hours per week
 - C) less than 13 and more than 23 hours per week
 - D) between 8 and 28 hours per week

Answer: D

- 104) A sociologist recently conducted a survey of citizens over 60 years of age who have net worths too high to qualify for Medicaid but have no private health insurance. The ages of the 25 uninsured senior citizens were as follows:

68 73 66 76 86 74 61 89 65 90 69 92 76
62 81 63 68 81 70 73 60 87 75 64 82

Suppose the mean and standard deviation are 74.04 and 9.75, respectively. If we assume that the distribution of ages is mound-shaped and symmetric, what percentage of the respondents will be between 64.29 and 93.54 years old?

- A) approximately 84%
- B) approximately 68%
- C) approximately 81.5%
- D) approximately 95%

Answer: C

- 105) A small computing center has found that the number of jobs submitted per day to its computers has a distribution that is approximately mound-shaped and symmetric, with a mean of 84 jobs and a standard deviation of 9. Where do we expect approximately 95% of the distribution to fall?
- A) between 66 and 102 jobs per day
 - B) between 102 and 111 jobs per day
 - C) between 57 and 111 jobs per day
 - D) between 75 and 93 jobs per day

Answer: A

- 106) A study was designed to investigate the effects of two variables — (1) a student's level of mathematical anxiety and (2) teaching method — on a student's achievement in a mathematics course. Students who had a low level of mathematical anxiety were taught using the traditional expository method. These students obtained a mean score of 490 with a standard deviation of 20 on a standardized test. Assuming a mound-shaped and symmetric distribution, what percentage of scores exceeded 450?
- A) approximately 100%
 - B) approximately 97.5%
 - C) approximately 84%
 - D) approximately 95%

Answer: B

- 107) A study was designed to investigate the effects of two variables — (1) a student's level of mathematical anxiety and (2) teaching method — on a student's achievement in a mathematics course. Students who had a low level of mathematical anxiety were taught using the traditional expository method. These students obtained a mean score of 370 with a standard deviation of 50 on a standardized test. Assuming a mound-shaped and symmetric distribution, in what range would approximately 95% of the students score?
- A) between 270 and 470
 - B) above 470
 - C) below 270 and above 470
 - D) below 470

Answer: A

- 108) A recent survey was conducted to compare the cost of solar energy to the cost of gas or electric energy. Results of the survey revealed that the distribution of the amount of the monthly utility bill of a 3-bedroom house using gas or electric energy had a mean of \$92 and a standard deviation of \$13. If the distribution can be considered mound-shaped and symmetric, what percentage of homes will have a monthly utility bill of more than \$79?
- A) approximately 84%
 - B) approximately 34%
 - C) approximately 95%
 - D) approximately 16%

Answer: A

- 109) Many firms use on-the-job training to teach their employees computer programming. Suppose you work in the personnel department of a firm that just finished training a group of its employees to program, and you have been requested to review the performance of one of the trainees on the final test that was given to all trainees. The mean and standard deviation of the test scores are 80 and 5, respectively, and the distribution of scores is mound-shaped and symmetric. What percentage of test-takers scored better than a trainee who scored 65?
- A) approximately 95%
 - B) approximately 100%
 - C) approximately 84%
 - D) approximately 97.5%

Answer: B

SHORT ANSWER. Write the word or phrase that best completes each statement or answers the question.

- 110) At the U.S. Open Tennis Championship a statistician keeps track of every serve that a player hits during the tournament. The statistician reported that the mean serve speed of a particular player was 104 miles per hour (mph) and the standard deviation of the serve speeds was 15 mph. Assume that the statistician also gave us the information that the distribution of serve speeds was mound-shaped and symmetric. Find the percentage of serves that were hit faster than 59 mph.

Answer: We use the Empirical Rule to determine the percentage of serves with speeds faster than 59 mph. We do this by first finding the percentage of serves with speeds between 59 and 104 mph. The Empirical Rule states that approximately 47.5% ($95\%/2$) fall between 59 and 104 mph. Because the distribution is symmetric about the mean speed of 104 mph, we know 50% of the serve speeds were faster than 104 mph. We add these findings together to determine that $47.5\% + 50\% = 97.5\%$ of the serves were hit faster than 59 mph.

- 111) A small computing center has found that the number of jobs submitted per day to its computers has a distribution that is approximately mound-shaped and symmetric, with a mean of 84 jobs and a standard deviation of 6. On what percentage of days do the number of jobs submitted exceed 90?

Answer: The value 90 falls one standard deviation above the mean in the distribution. Using the Empirical Rule, 68% of the days will have between 78 and 90 jobs submitted. Of the remaining 32% of the days, half, or $32\%/2 = 16\%$, of the days will have more than 90 jobs submitted.

112) By law, a box of cereal labeled as containing 24 ounces must contain at least 24 ounces of cereal. The machine filling the boxes produces a distribution of fill weights that is mound-shaped and symmetric, with a mean equal to the setting on the machine and with a standard deviation equal to 0.04 ounce. To ensure that most of the boxes contain at least 24 ounces, the machine is set so that the mean fill per box is 24.12 ounces. What percentage of the boxes do, in fact, contain at least 24 ounces?

Answer: The value of 24 ounces falls three standard deviations below the mean. The Empirical Rule states that approximately all of the boxes will contain cereal amounts between 24.00 ounces and 24.24 ounces. Therefore, approximately 100% of the boxes contain at least 24 ounces.

113) Many firms use on-the-job training to teach their employees computer programming. Suppose you work in the personnel department of a firm that just finished training a group of its employees to program, and you have been requested to review the performance of one of the trainees on the final test that was given to all trainees. The mean and standard deviation of the test scores are 76 and 2, respectively, and the distribution of scores is mound-shaped and symmetric. If a firm wanted to give the best 2.5% of the trainees a big promotion, what test score would be used to identify the trainees in question?

Answer: The Empirical Rule states that 95% of the data will fall between 72 and 80. Because the distribution is symmetric, half of the remaining 5%, or 2.5%, will have test scores above 80. Thus, 80 is the cutoff point that will identify the trainees who will receive the promotion.

114) The following data represent the scores of 50 students on a statistics exam. The mean score is 80.02, and the standard deviation is 11.9.

39	51	59	63	66	68	68	69	70	71
71	71	73	74	76	76	76	77	78	79
79	79	79	80	80	82	83	83	83	85
85	86	86	88	88	88	88	89	89	89
90	90	91	91	92	95	96	97	97	98

What percentage of the scores lies within one standard deviation of the mean? two standard deviations of the mean? three standard deviations of the mean? Based on these percentages, do you believe that the distribution of scores is mound-shaped and symmetric? Explain.

Answer: 74% of the scores lie within one standard deviation of the mean, 96% within two standard deviations, and 98% within three standard deviations. These percentages are close to those given in the Empirical Rule, so the distribution is roughly mound-shaped and symmetric, though obviously skewed slightly to the left.

MULTIPLE CHOICE. Choose the one alternative that best completes the statement or answers the question.

115) The distribution of scores on a test is mound-shaped and symmetric with a mean score of 78. If 68% of the scores fall between 72 and 84, which of the following is most likely to be the standard deviation of the distribution?

- A) 2
- B) 6
- C) 3
- D) 12

Answer: B

- 116) At the U.S. Open Tennis Championship a statistician keeps track of every serve that a player hits during the tournament. The statistician reported that the mean serve speed was 100 miles per hour (mph) and the standard deviation of the serve speeds was 15 mph. If nothing is known about the shape of the distribution, what percentage of the player's serve speeds are less than 70 mph?
- A) approximately 2.5%
 - B) at most 12.5%
 - C) at most 25%
 - D) at most 11%
 - E) approximately 5%

Answer: C

- 117) At the U.S. Open Tennis Championship a statistician keeps track of every serve that a player hits during the tournament. The statistician reported that the mean serve speed of a particular player was 100 miles per hour (mph) and the standard deviation of the serve speeds was 8 mph. If nothing is known about the shape of the distribution, give an interval that will contain the speeds of at least eight-ninths of the player's serves.
- A) 84 mph to 116 mph
 - B) 76 mph to 124 mph
 - C) 124 mph to 148 mph
 - D) 68 mph to 132 mph

Answer: B

- 118) The amount of time workers spend commuting to their jobs each day in a large metropolitan city has a mean of 70 minutes and a standard deviation of 20 minutes. Assuming nothing is known about the shape of the distribution of commuting times, what percentage of these commuting times are between 30 and 110 minutes?
- A) at least 89%
 - B) at least 95%
 - C) at least 75%
 - D) at least 0%

Answer: C

- 119) By law, a box of cereal labeled as containing 20 ounces must contain at least 20 ounces of cereal. The machine filling the boxes produces a distribution of fill weights with a mean equal to the setting on the machine and with a standard deviation equal to 0.02 ounce. To ensure that most of the boxes contain at least 20 ounces, the machine is set so that the mean fill per box is 20.06 ounces. Assuming nothing is known about the shape of the distribution, what can be said about the proportion of cereal boxes that contain less than 20 ounces.
- A) The proportion is at most 5.5%.
 - B) The proportion is at most 11%.
 - C) The proportion is at least 89%.
 - D) The proportion is less than 2.5%.

Answer: B

- 120) A study was designed to investigate the effects of two variables — (1) a student's level of mathematical anxiety and (2) teaching method — on a student's achievement in a mathematics course. Students who had a low level of mathematical anxiety were taught using the traditional expository method. These students obtained a mean score of 310 with a standard deviation of 20 on a standardized test. Assuming no information concerning the shape of the distribution is known, what percentage of the students scored between 270 and 350?
- A) approximately 95%
 - B) approximately 68%
 - C) at least 75%
 - D) at least 89%

Answer: C

- 121) A study was designed to investigate the effects of two variables — (1) a student's level of mathematical anxiety and (2) teaching method — on a student's achievement in a mathematics course. Students who had a low level of mathematical anxiety were taught using the traditional expository method. These students obtained a mean score of 490 with a standard deviation of 40 on a standardized test. Assuming a non-mound-shaped distribution, what percentage of the students scored over 610?
- A) approximately 2.5%
 - B) at most 5.5%
 - C) at least 89%
 - D) at most 11%

Answer: D

- 122) A recent survey was conducted to compare the cost of solar energy to the cost of gas or electric energy. Results of the survey revealed that the distribution of the amount of the monthly utility bill of a 3-bedroom house using gas or electric energy had a mean of \$110 and a standard deviation of \$10. If nothing is known about the shape of the distribution, what percentage of homes will have a monthly utility bill of less than \$90?
- A) at most 25%
 - B) at least 88.9%
 - C) at most 11.1%
 - D) at least 75%

Answer: A

- 123) Many firms use on-the-job training to teach their employees computer programming. Suppose you work in the personnel department of a firm that just finished training a group of its employees to program, and you have been requested to review the performance of one of the trainees on the final test that was given to all trainees. The mean and standard deviation of the test scores are 83 and 3, respectively. Assuming nothing is known about the distribution, what percentage of test-takers scored above 89?
- A) approximately 2.5%
 - B) at least 75%
 - C) approximately 97.5%
 - D) at most 25%

Answer: D

- 124) If nothing is known about the shape of a distribution, what percentage of the observations fall within 3 standard deviations of the mean?
- A) at least 89%
 - B) approximately 99.7%
 - C) approximately 0.3%
 - D) at most 11%

Answer: A

- 125) Fill in the blank. _____ gives us a method of interpreting the standard deviation of any data set, regardless of the shape of the distribution.
- A) The Empirical Rule
 - B) Chebyshev's Rule
 - C) both A and B
 - D) neither A nor B

Answer: B

- 126) Fill in the blank. _____ is a method of interpreting the standard deviation of data that have a mound-shaped, symmetric distribution.
- A) The Empirical Rule
 - B) Chebyshev's Rule
 - C) both A and B
 - D) neither A nor B

Answer: A

- 127) Given a data set, which of the following is most likely to be the percentage of data within three standard deviations of the mean?
- A) 70%
 - B) 85%
 - C) 95%
 - D) 65%

Answer: C

Answer the question True or False.

- 128) Both Chebyshev's rule and the empirical rule guarantee that no data item will be more than four standard deviations from the mean.
- A) True
 - B) False

Answer: B

- 129) Chebyshev's rule applies to qualitative data sets, while the empirical rule applies to quantitative data sets.
- A) True
 - B) False

Answer: B

- 130) Chebyshev's rule applies to large data sets, while the empirical rule applies to small data sets.
- A) True
 - B) False

Answer: B

- 131) Your teacher announces that the scores on a test have a mean of 83 points with a standard deviation of 4 points, so it is reasonable to expect that you scored at least 70 on the test.
- A) True
 - B) False

Answer: A

Solve the problem.

- 132) Many firms use on-the-job training to teach their employees computer programming. Suppose you work in the personnel department of a firm that just finished training a group of its employees to program, and you have been requested to review the performance of one of the trainees on the final test that was given to all trainees. The mean and standard deviation of the test scores are 75 and 3, respectively, and the distribution of scores is mound-shaped and symmetric. Suppose the trainee in question received a score of 71. Compute the trainee's z-score.
- A) $z = -12$
 - B) $z = 0.91$
 - C) $z = -1.33$
 - D) $z = -4$

Answer: C

133) The amount spent on textbooks for the fall term was recorded for a sample of five hundred university students. The mean expenditure was calculated to be \$500 and the standard deviation of the expenditures was calculated to be \$100. Suppose a randomly selected student reported that their textbook expenditure was \$700. Calculate the z-score for this student's textbook expenditure.

- A) -3
- B) +2
- C) +3
- D) -2

Answer: B

134) A recent survey was conducted to compare the cost of solar energy to the cost of gas or electric energy. Results of the survey revealed that the distribution of the amount of the monthly utility bill of a 3-bedroom house using gas or electric energy had a mean of \$113 and a standard deviation of \$11. Three solar homes reported monthly utility bills of \$73, \$76, and \$72. Which of the following statements is true?

- A) Homes using solar power always have lower utility bills than homes using only gas and electricity.
- B) The utility bills for homes using solar power are about the same as those for homes using only gas and electricity.
- C) Homes using solar power may have lower utility bills than homes using only gas and electricity.
- D) Homes using solar power may actually have higher utility bills than homes using only gas and electricity.

Answer: C

135) A radio station claims that the amount of advertising each hour has a mean of 17 minutes and a standard deviation of 2.1 minutes. You listen to the radio station for 1 hour and observe that the amount of advertising time is 13 minutes. Calculate the z-score for this amount of advertising time.

- A) $z = 1.90$
- B) $z = 0.64$
- C) $z = -1.90$
- D) $z = -8.4$

Answer: C

136) On a given day, the price of a gallon of milk had a mean price of \$2.71 with a standard deviation of \$0.05. A particular food store sold milk for \$2.66/gallon. Interpret the z-score for this gas station.

- A) The milk price of this food store falls 5 standard deviations below the mean milk price of all food stores.
- B) The milk price of this food store falls 5 standard deviations above the mean milk price of all food stores.
- C) The milk price of this food store falls 1 standard deviation above the mean milk price of all food stores.
- D) The milk price of this food store falls 1 standard deviation below the milk price of all food stores.

Answer: D

137) Which of the following is a measure of relative standing?

- A) mean
- B) pie chart
- C) variance
- D) z-score

Answer: D

SHORT ANSWER. Write the word or phrase that best completes each statement or answers the question.

- 138) A study was designed to investigate the effects of two variables – (1) a student's level of mathematical anxiety and (2) teaching method – on a student's achievement in a mathematics course. Students who had a low level of mathematical anxiety were taught using the traditional expository method. These students obtained a mean score of 320 and a standard deviation of 20 on a standardized test. Find and interpret the z-score of a student who scored 500 on the standardized test.

Answer: The z-score is $z = \frac{x - \mu}{\sigma}$.

$$\text{For a score of 50, } z = \frac{500 - 320}{20} = 9.00.$$

This student's score falls 9.00 standard deviations above the mean score of 320.

- 139) A recent survey was conducted to compare the cost of solar energy to the cost of gas or electric energy. Results of the survey revealed that the distribution of the amount of the monthly utility bill of a 3-bedroom house using gas or electric energy had a mean of \$118.00 and a standard deviation of \$14.00. Assuming the distribution is mound-shaped and symmetric, would you expect to see a 3-bedroom house using gas or electric energy with a monthly utility bill of \$202.00? Explain.

Answer: The z-score for the value \$202.00 is:

$$z = \frac{x - \bar{x}}{s} = \frac{202 - 118}{14} = 6$$

An observation that falls 6 standard deviations above the mean is very unlikely. We would not expect to see a monthly utility bill of \$202.00 for this home.

MULTIPLE CHOICE. Choose the one alternative that best completes the statement or answers the question.

- 140) Find the z-score for the value 74, when the mean is 58 and the standard deviation is 2.

- A) $z = 1.24$
- B) $z = -1.24$
- C) $z = 8.00$
- D) $z = 7.50$

Answer: C

SHORT ANSWER. Write the word or phrase that best completes each statement or answers the question.

- 141) Test scores for a history class had a mean of 79 with a standard deviation of 4.5. Test scores for a physics class had a mean of 69 with a standard deviation of 3.7. One student earned a 55 on the history test and a 66 on the physics test. Calculate the z-score for each test. On which test did the student perform better?

Answer: history z-score = -5.33; physics z-score = -0.81; The student performed better on the physics test.

142) The following data represent the scores of 50 students on a statistics exam. The mean score is 80.02, and the standard deviation is 11.9.

39 51 59 63 66 68 68 69 70 71
71 71 73 74 76 76 76 77 78 79
79 79 79 80 80 82 83 83 83 85
85 86 86 88 88 88 88 89 89 89
90 90 91 91 92 95 96 97 97 98

Find the z -scores for the highest and lowest exam scores.

Answer: highest: $z = 1.51$; lowest: $z = -3.45$

143) The z -score for a value x is -2.5 . State whether the value of x lies above or below the mean and by how many standard deviations.

Answer: The value of x lies 2.5 standard deviations below the mean.

144) Suppose that 50 and 75 are two elements of a population data set and their z -scores are -3 and 2 , respectively. Find the mean and standard deviation.

Answer: mean: 65; standard deviation: 5

MULTIPLE CHOICE. Choose the one alternative that best completes the statement or answers the question.

Answer the question True or False.

145) According to the empirical rule, z -scores of less than -3 or greater than 3 occur very infrequently for data from a mound and symmetric distribution

A) True

B) False

Answer: A

146) If a z -score is 0 or near 0, the measurement is located at or near the mean.

A) True

B) False

Answer: A

147) If a sample has mean 0 and standard deviation 1, then for every measurement x in the sample the z -score of x is x itself.

A) True

B) False

Answer: A

Solve the problem.

- 148) When Scholastic Achievement Test scores (SATs) are sent to test-takers, the percentiles associated with scores are also given. Suppose a test-taker scored at the 98th percentile on the verbal part of the test and at the 14th percentile on the quantitative part. Interpret these results.
- A) This student performed better than 2% of the other test-takers on the verbal part and better than 14% on the quantitative part.
 - B) This student performed better than 98% of the other test-takers on the verbal part and better than 86% on the quantitative part.
 - C) This student performed better than 2% of the other test-takers on the verbal part and better than 86% on the quantitative part.
 - D) This student performed better than 98% of the other test-takers on the verbal part and better than 14% on the quantitative part.

Answer: D

- 149) The amount spent on textbooks for the fall term was recorded for a sample of five hundred university students. It was determined that the 75th percentile was the value \$500. Which of the following interpretations of the 75th percentile is correct?
- A) 75% of the students sampled had textbook costs equal to \$500.
 - B) The average of the 500 textbook costs was \$500.
 - C) 75% of the students sampled had textbook costs that exceeded \$500.
 - D) 25% of the students sampled had textbook costs that exceeded \$500.

Answer: D

- 150) Summary information is given for the weights (in pounds) of 1000 randomly sampled tractor trailers.

MIN:	4008	25%:	5608
MAX:	10,608	75%:	8608
AVE:	7008	Std. Dev.:	1400

Find the percentage of tractor trailers with weights between 5608 and 8608 pounds.

- A) 100%
- B) 75%
- C) 50%
- D) 25%

Answer: C

- 151) The test scores of 30 students are listed below. Which number could be the 30th percentile?

31 41 45 48 52 55 56 56 63 65
67 67 69 70 70 74 75 78 79 79
80 81 83 85 85 87 90 92 95 99

- A) 64
- B) 67
- C) 56
- D) 90

Answer: A

SHORT ANSWER. Write the word or phrase that best completes each statement or answers the question.

152) A retail store's customer satisfaction rating is at the 88th percentile. What percentage of retail stores has higher customer satisfaction ratings than this store?

Answer: 12%

153) In a summary of recent real estate sales, the median home price is given as \$325,000. What percentile corresponds to a home price of \$325,000?

Answer: 50th percentile

MULTIPLE CHOICE. Choose the one alternative that best completes the statement or answers the question.

Answer the question True or False.

154) The mean of a data set is at the 50th percentile.

- A) True
- B) False

Answer: B

155) Percentile rankings are of practical value only with large data sets.

- A) True
- B) False

Answer: A

156) The process for finding a percentile is similar to the process for finding the median.

- A) True
- B) False

Answer: A

Solve the problem.

157) At the U.S. Open Tennis Championship a statistician keeps track of every serve that a player hits during the tournament. The statistician reported that the mean serve speed of a particular player was 98 miles per hour (mph) and the standard deviation of the serve speeds was 14 mph. Using the z-score approach for detecting outliers, which of the following serve speeds would represent outliers in the distribution of the player's serve speeds?

Speeds: 49 mph, 112 mph, and 126 mph

- A) 49 is the only outlier.
- B) 49, 112, and 126 are all outliers.
- C) None of the three speeds is an outlier.
- D) 49 and 112 are both outliers, but 126 is not.

Answer: A

158) At the U.S. Open Tennis Championship a statistician keeps track of every serve that a player hits during the tournament. The statistician reported that the mean serve speed of a particular player was 100 miles per hour (mph) and the standard deviation of the serve speeds was 15 mph. Using the z-score approach for detecting outliers, which of the following serve speeds would represent outliers in the distribution of the player's serve speeds?

Speeds: 50 mph, 80 mph, and 105 mph

- A) 50 is the only outlier.
- B) None of the three speeds are outliers.
- C) 50, 80, and 105 are all outliers.
- D) 50 and 80 are both outliers, 105 is not.

Answer: A

159) The speeds of the fastballs thrown by major league baseball pitchers were measured by radar gun. The mean speed was 84 miles per hour. The standard deviation of the speeds was 6 mph. Which of the following speeds would be classified as an outlier?

- A) 103 mph
- B) 93 mph
- C) 72 mph
- D) 78 mph

Answer: A

160) Which of the following statements concerning the box plot and z-score methods for detecting outliers is false?

- A) The box plot method uses the quartiles as a basis for detecting outliers.
- B) The box plot method is less affected by an extreme observation in the data set.
- C) The z-score method uses the mean and standard deviation as a basis for detecting outliers.
- D) The z-score method is less affected by an extreme observation in the data set.

Answer: D

161) Which of the following statements could be an explanation for the presence of an outlier in the data?

- A) The measurement belongs to a population different from that from which the rest of the sample was drawn.
- B) The measurement is incorrect. It may have been observed, recorded, or entered into the computer incorrectly.
- C) The measurement may be correct and from the same population as the rest but represents a rare event. Generally, we accept this explanation only after carefully ruling out all others.
- D) All of the above are explanations for outliers.

Answer: D

SHORT ANSWER. Write the word or phrase that best completes each statement or answers the question.

162) A radio station claims that the amount of advertising each hour has a mean of 16 minutes and a standard deviation of 2.2 minutes. You listen to the radio station for 1 hour and observe that the amount of advertising time is 10.72 minutes. Based on your observation, what would you infer about the radio station's claim?

Answer: The z-score for the value 10.72 is -2.4

Since the z-score would not indicate that 10.72 minutes represents an outlier, there is no evidence that the station's claim is incorrect.

163) The following data represent the scores of 50 students on a statistics exam. The mean score is 80.02, and the standard deviation is 11.9.

39	51	59	63	66	68	68	69	70	71
71	71	73	74	76	76	76	77	78	79
79	79	79	80	80	82	83	83	83	85
85	86	86	88	88	88	88	89	89	89
90	90	91	91	92	95	96	97	97	98

Use the z-score method to identify potential outliers among the scores.

Answer: The z-score of 39 is -3.46 . Since this z-score is less than -3 , the score of 39 is an outlier. All other scores have z-scores between -3 and 3 , so there are no other outliers.

MULTIPLE CHOICE. Choose the one alternative that best completes the statement or answers the question.

Answer the question True or False.

164) The z-score uses the quartiles to identify outliers in a data set.

- A) True
- B) False

Answer: B

165) An outlier is defined as any observation that falls within the outer fences of a box plot.

- A) True
- B) False

Answer: B

166) Box plots are used to detect outliers in qualitative data sets, while z-scores are used to detect outliers in quantitative data sets.

- A) True
- B) False

Answer: B

167) An outlier in a data set may have a simple explanation such as a scale was not working properly or the researcher inverted the digits of a number when recording a measurement.

- A) True
- B) False

Answer: A

168) An outlier may be caused by accidentally including the height of a six-year-old boy in a set of data representing the heights of 12-year-old boys.

- A) True
- B) False

Answer: A

169) The outer fences of a box plot are three standard deviations from the mean.

- A) True
- B) False

Answer: B

Solve the problem.

- 170) At the U.S. Open Tennis Championship a statistician keeps track of every serve that a player hits during the tournament. The lower quartile of a particular player's serve speeds was reported to be 97 mph. Which of the following interpretations of this information is correct?
- A) 75% of the player's serves were hit at speeds less than 97 mph.
 - B) 97 serves traveled faster than the lower quartile.
 - C) 75% of the player's serves were hit at speeds greater than 97 mph.
 - D) 25% of the player's serves were hit at 97 mph.

Answer: C

- 171) A sociologist recently conducted a survey of citizens over 60 years of age who have net worths too high to qualify for Medicaid but have no private health insurance. The ages of the 25 uninsured senior citizens were as follows:

68 73 66 76 86 74 61 89 65 90 69 92 76
62 81 63 68 81 70 73 60 87 75 64 82

Find the upper quartile of the data.

- A) 73
- B) 92
- C) 65.5
- D) 81.5

Answer: D

SHORT ANSWER. Write the word or phrase that best completes each statement or answers the question.

- 172) The amount of television viewed by today's youth is of primary concern to Parents Against Watching Television (PAWT). Three hundred parents of elementary school-aged children were asked to estimate the number of hours per week that their child watches television. The upper quartile for the distribution was given as 14 hours. Interpret this value.

Answer: 75% of the TV viewing times are less than 14 hours per week. 25% of the times exceed 14 hours per week.

- 173) For a given data set, the lower quartile is 45, the median is 50, and the upper quartile is 57. The minimum value in the data set is 32, and the maximum is 81.
- a. Find the interquartile range.
 - b. Find the inner fences.
 - c. Find the outer fences.
 - d. Is either of the minimum or maximum values considered an outlier? Explain.

Answer: a. The interquartile range is $57 - 45 = 12$.

b. The inner fences are $45 - 1.5(12) = 27$ and $57 + 1.5(12) = 75$.

c. The outer fences are $45 - 3(12) = 9$ and $57 + 3(12) = 93$.

d. The maximum of 81 is a potential outlier since it lies outside the inner fences. The minimum is within the inner fence and is not considered to be an outlier.

174) The calculator screens summarize a data set.

```
1-Var Stats
x̄=79.95238095
Σx=1679
Σx²=138471
Sx=14.54467666
σx=14.19415101
↓n=21
```

```
1-Var Stats
↑n=21
minX=30
Q1=75
Med=82
Q3=90
maxX=97
```

- Identify the lower and upper quartiles of the data set.
- Find the interquartile range.
- Is there reason to suspect that the data may contain an outlier? Explain.

Answer: a. lower quartile: $Q1=75$; upper quartile: $Q3=90$

b. interquartile range: $90 - 75 = 15$

c. Yes; the smallest measurement, 30, is three times the interquartile range less than the lower quartile, so it is a suspected outlier.

MULTIPLE CHOICE. Choose the one alternative that best completes the statement or answers the question.

175) The box plot shown below displays the amount of soda that was poured by a filling machine into 12-ounce soda cans at a local bottling company.

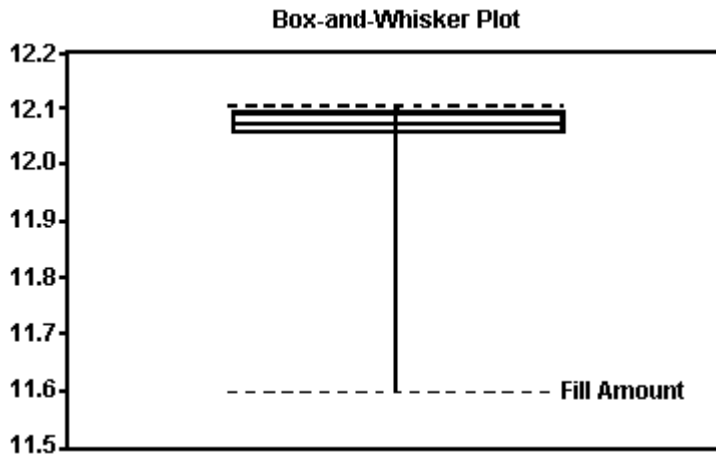

Based on the box plot, what shape do you believe the distribution of the data to have?

- approximately symmetric
- skewed to the right
- skewed to the center
- skewed to the left

Answer: D

176) The box plot shown below was constructed for the amount of soda that was poured by a filling machine into 12-ounce soda cans at a local soda bottling company.



We see that one soda can received 12.15 ounces of soda on the plot above. Based on the box plot presented, how would you classify this observation?

- A) highly suspect outlier
- B) suspect outlier
- C) it has a lot of soda
- D) expected observation

Answer: B

177) The box plot shown below was constructed for the amount of soda that was poured by a filling machine into 12-ounce soda cans at a local soda bottling company.

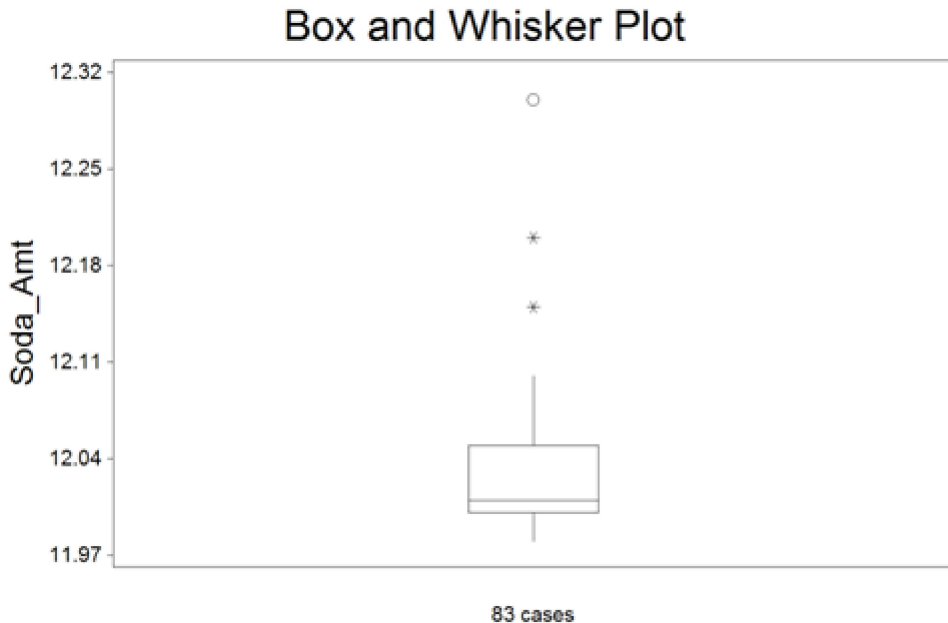

We see that one soda can received 12.30 ounces of soda on the plot above. Based on the box plot presented, how would you classify this observation?

- A) expected observation
- B) highly suspect outlier
- C) it has a lot of soda
- D) suspect outlier

Answer: B

SHORT ANSWER. Write the word or phrase that best completes each statement or answers the question.

178) The following data represent the scores of 50 students on a statistics exam.

39	51	59	63	66	68	68	69	70	71
71	71	73	74	76	76	76	77	78	79
79	79	79	80	80	82	83	83	83	85
85	86	86	88	88	88	88	89	89	89
90	90	91	91	92	95	96	97	97	98

- a. Find the lower quartile, the upper quartile, and the median of the scores.
- b. Find the interquartile range of the data and use it to identify potential outliers.
- c. In a box plot for the data, which scores, if any, would be outside the outer fences? Which scores, if any, would be outside the inner fences but inside the outer fences?

Answer: a. The lower quartile is 73, the upper quartile is 89, and the median is 81.

b. The interquartile range is $89 - 73 = 16$. The score of 39 is a potential outlier since it is less than $73 - 1.5(16) = 49$.

c. No scores fall outside the outer fences, 25 and 137. Only the score of 39 lies between the inner and outer fences.

179) Use a graphing calculator or software to construct a box plot for the following data set.

12 18 14 17 19 16 14 18 15 17 11
 13 14 11 16 18 15 13 17 15 14 19
 12 16 17

Answer: The horizontal axis extends from 10 to 20, with each tick mark representing one unit.

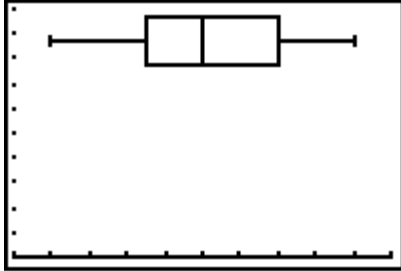

MULTIPLE CHOICE. Choose the one alternative that best completes the statement or answers the question.

180) A sample of professional golfers was taken and their driving distance (measured as the average distance as their drive off the tee) and driving accuracy (measured as the percentage of fairways that their drives landed in) were recorded. A scatterplot of the variables is shown below.

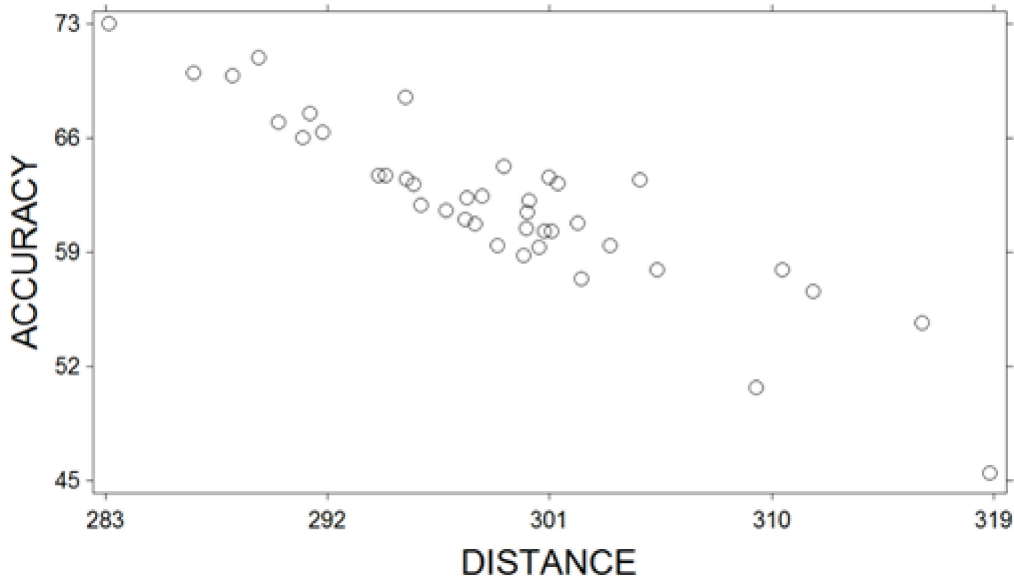

What relationship do these two variables exhibit?

- A) They exhibit a curvilinear relationship
- B) They exhibit a positive linear relationship
- C) They exhibit no relationship
- D) They exhibit a negative linear relationship

Answer: D

SHORT ANSWER. Write the word or phrase that best completes each statement or answers the question.

181) The data below represent the numbers of absences and the final grades of 15 randomly selected students from a statistics class. Construct a scattergram for the data. Do you detect a trend?

Student	Number of Absences	Final Grade as a Percent
1	5	79
2	6	78
3	2	86
4	12	56
5	9	75
6	5	90
7	8	78
8	15	48
9	0	92
10	1	78
11	9	81
12	3	86
13	10	75
14	3	89
15	11	65

Answer:

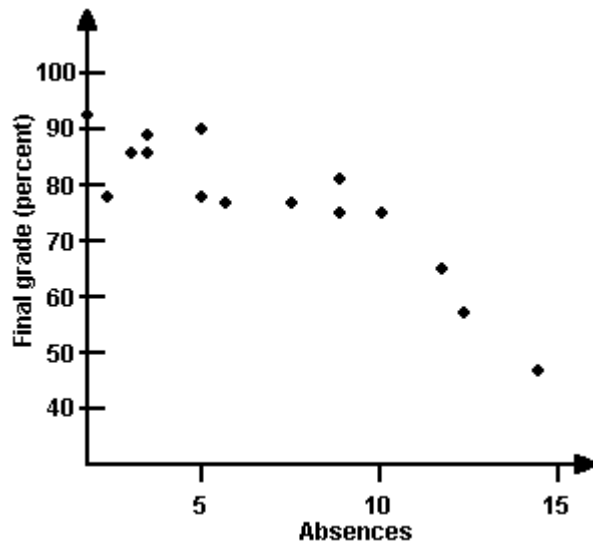

There appears to be a trend in the data. As the number of absences increases, the final grade decreases.

182) The scores of nine members of a women's golf team in two rounds of tournament play are listed below.

Player	1	2	3	4	5	6	7	8	9
Round 1	85	90	87	78	92	85	79	93	86
Round 2	90	87	85	84	86	78	77	91	82

Construct a scattergram for the data.

Answer:

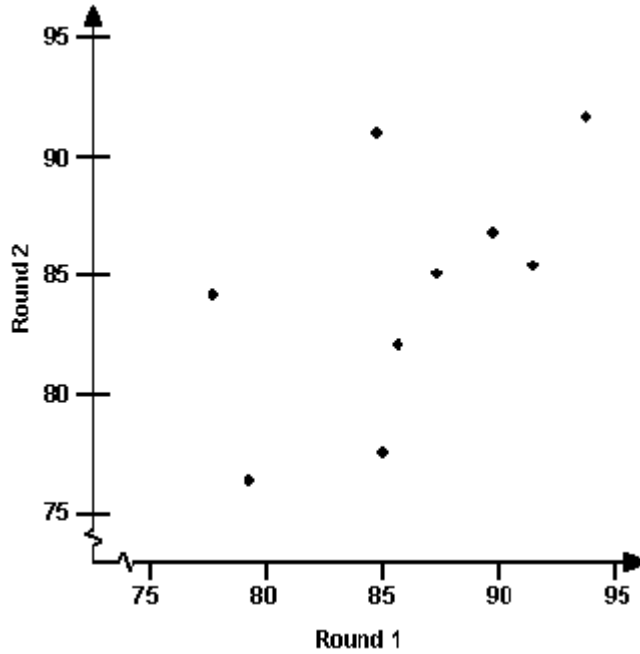

MULTIPLE CHOICE. Choose the one alternative that best completes the statement or answers the question.

Answer the question True or False.

183) Scatterplots are useful for both qualitative and quantitative data.

- A) True
- B) False

Answer: B

184) The scatterplot below shows a negative relationship between two variables.

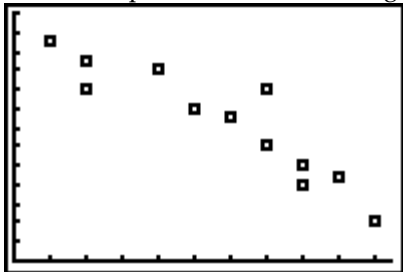

- A) True
- B) False

Answer: A

SHORT ANSWER. Write the word or phrase that best completes each statement or answers the question.

Solve the problem.

185) Explain how stretching the vertical axis of a histogram can be misleading.

Answer: Stretching the vertical axis may overemphasize the differences in the heights of the bars making the taller bars look much taller than the shorter bars.

186) Explain how using a scale break on the vertical axis of a histogram can be misleading.

Answer: Using a scale break on the vertical axis may make the shorter bars look disproportionately shorter than the taller bars.

187) Explain how it can be misleading to draw the bars in a histogram so that the width of each bar is proportional to its height rather than have all bars the same width.

Answer: The reader may think that the area of the bar represents the quantity rather than the height of the bar, giving a disproportionate emphasis on the taller bars.

188) Explain how it can be misleading to report only the mean of a distribution without any measure of the variability.

Answer: When comparing means from two different distributions, the difference between them may be insignificant if the variability in one or both of the distributions is large.